

CD4051BC • CD4052BC • CD4053BC

Single 8-Channel Analog Multiplexer/Demultiplexer • Dual 4-Channel Analog Multiplexer/Demultiplexer • Triple 2-Channel Analog Multiplexer/Demultiplexer

General Description

The CD4051BC, CD4052BC, and CD4053BC analog multiplexers/demultiplexers are digitally controlled analog switches having low "ON" impedance and very low "OFF" leakage currents. Control of analog signals up to 15V_{p-p} can be achieved by digital signal amplitudes of 3 – 15V. For example, if V_{DD} = 5V, V_{SS} = 0V and V_{EE} = -5V, analog signals from -5V to +5V can be controlled by digital inputs of 0 – 5V. The multiplexer circuits dissipate extremely low quiescent power over the full V_{DD}-V_{SS} and V_{DD}-V_{EE} supply voltage ranges, independent of the logic state of the control signals. When a logical "1" is present at the inhibit input terminal all channels are "OFF".

CD4051BC is a single 8-channel multiplexer having three binary control inputs, A, B, and C, and an inhibit input. The three binary signals select 1 of 8 channels to be turned "ON" and connect the input to the output.

CD4052BC is a differential 4-channel multiplexer having two binary control inputs, A and B, and an inhibit input. The two binary input signals select 1 or 4 pairs of channels to be turned on and connect the differential analog inputs to the differential outputs.

CD4053BC is a triple 2-channel multiplexer having three separate digital control inputs, A, B, and C, and an inhibit input. Each control input selects one of a pair of channels which are connected in a single-pole double-throw configuration.

Features

- Wide range of digital and analog signal levels: digital 3 – 15V, analog to 15V_{p-p}
- Low "ON" resistance: 80Ω (typ.) over entire 15V_{p-p} signal-input range for V_{DD} – V_{EE} = 15V
- High "OFF" resistance: channel leakage of ±10 pA (typ.) at V_{DD} – V_{EE} = 10V
- Logic level conversion for digital addressing signals of 3 – 15V (V_{DD} – V_{SS} = 3 – 15V) to switch analog signals to 15 V_{p-p} (V_{DD} – V_{EE} = 15V)
- Matched switch characteristics: ΔR_{ON} = 5Ω (typ.) for V_{DD} – V_{EE} = 15V
- Very low quiescent power dissipation under all digital-control input and supply conditions: 1 μW (typ.) at V_{DD} – V_{SS} = V_{DD} – V_{EE} = 10V
- Binary address decoding on chip

Ordering Code:

Order Number	Package Number	Package Description
CD4051BCM	M16A	16-Lead Small Outline Integrated Circuit (SOIC), JEDEC MS-012, 0.150" Narrow
CD4051BCMTC	MTC16	16-Lead Thin Shrink Small Outline Package (TSSOP), JEDEC MO-153, 4.4mm Wide
CD4051BCN	N16E	16-Lead Plastic Dual-In-Line Package (PDIP), JEDEC MS-001, 0.300" Wide
CD4052BCM	M16A	16-Lead Small Outline Integrated Circuit (SOIC), JEDEC MS-012, 0.150" Narrow
CD4052BCSJ	M16D	16-Lead Small Outline Package (SOP), EIAJ TYPE II, 5.3mm Wide
CD4052BCN	N16E	16-Lead Plastic Dual-In-Line Package (PDIP), JEDEC MS-001, 0.300" Wide
CD4053BCM	M16A	16-Lead Small Outline Integrated Circuit (SOIC), JEDEC MS-012, 0.150" Narrow
CD4053BCSJ	M16D	16-Lead Small Outline Package (SOP), EIAJ TYPE II, 5.3mm Wide
CD4053BCN	N16E	16-Lead Plastic Dual-In-Line Package (PDIP), JEDEC MS-001, 0.300" Wide

Devices also available in Tape and Reel. Specify by appending the suffix letter "X" to the ordering code.

CD4051BC • CD4052BC • CD4053BC Single 8-Channel Analog Multiplexer/Demultiplexer • Dual 4-Channel Analog Multiplexer/Demultiplexer • Triple 2-Channel Analog Multiplexer/Demultiplexer

Connection Diagrams

Pin Assignments for DIP and SOIC

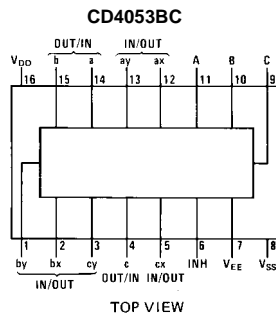
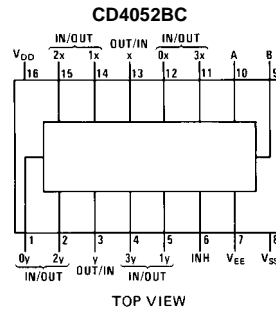
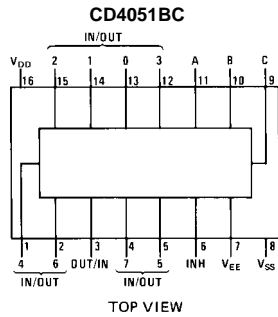

Truth Table

INPUT STATES				"ON" CHANNELS		
INHIBIT	C	B	A	CD4051B	CD4052B	CD4053B
0	0	0	0	0	0X, 0Y	cx, bx, ax
0	0	0	1	1	1X, 1Y	cx, bx, ay
0	0	1	0	2	2X, 2Y	cx, by, ax
0	0	1	1	3	3X, 3Y	cx, by, ay
0	1	0	0	4		cy, bx, ax
0	1	0	1	5		cy, bx, ay
0	1	1	0	6		cy, by, ax
0	1	1	1	7		cy, by, ay
1	*	*	*	NONE	NONE	NONE

*Don't Care condition.

Logic Diagrams

CD4051BC

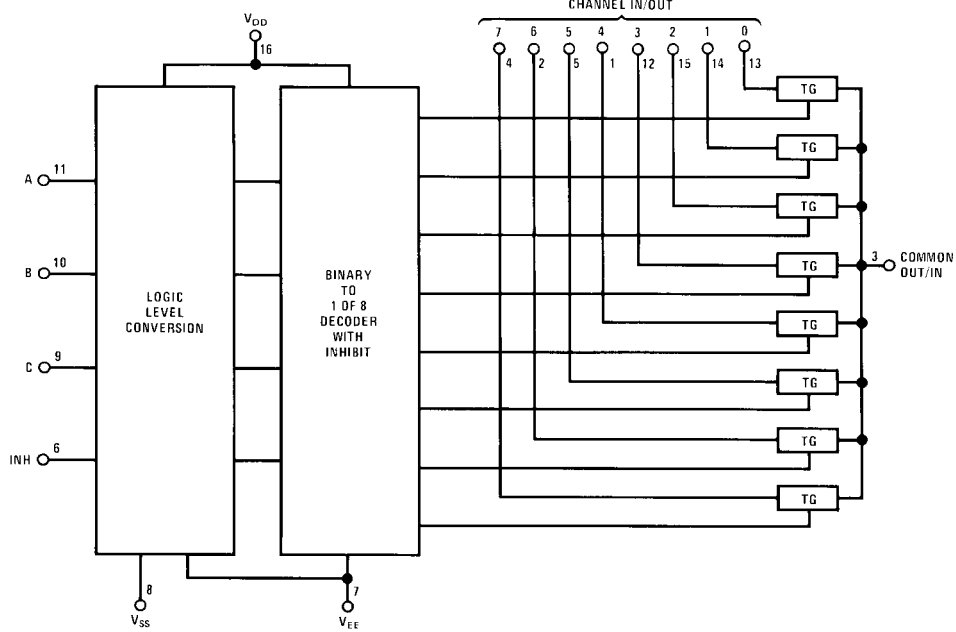

CD4052BC

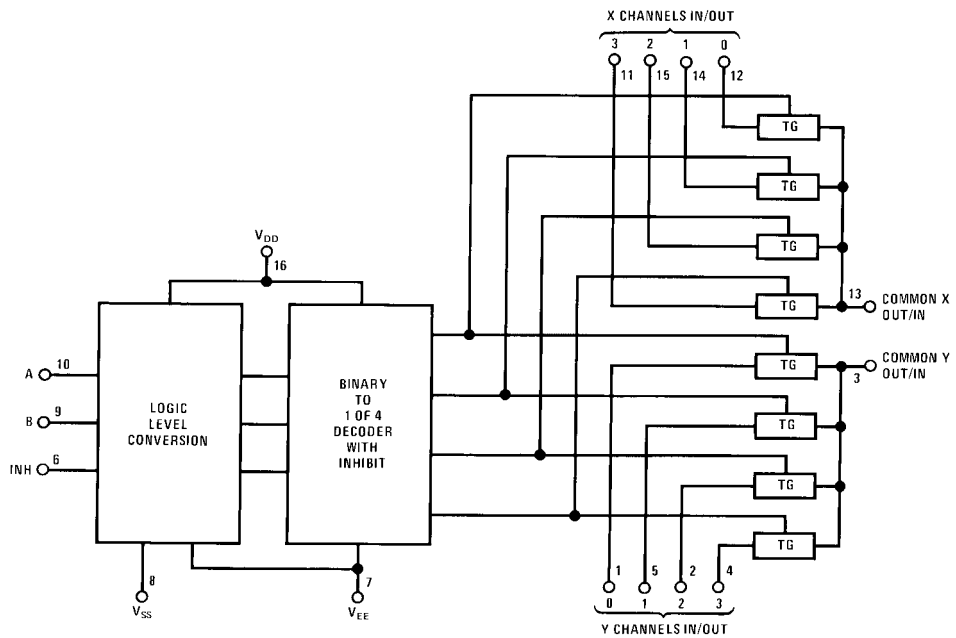

CD4051BC • CD4052BC • CD4053BC

Logic Diagrams (Continued)

CD4053BC

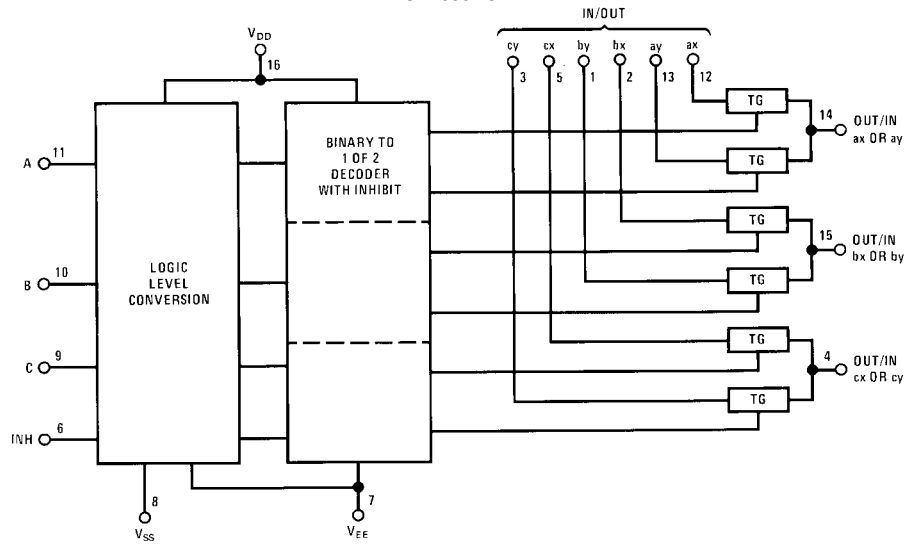

Absolute Maximum Ratings (Note 1)		Recommended Operating Conditions									
DC Supply Voltage (V_{DD})	$-0.5 V_{DC}$ to $+18 V_{DC}$	DC Supply Voltage (V_{DD})	$+5 V_{DC}$ to $+15 V_{DC}$								
Input Voltage (V_{IN})	$-0.5 V_{DC}$ to $V_{DD} + 0.5 V_{DC}$	Input Voltage (V_{IN})	$0V$ to $V_{DD} V_{DC}$								
Storage Temperature Range (T_S)	$-65^{\circ}C$ to $+150^{\circ}C$	Operating Temperature Range (T_A)	$-40^{\circ}C$ to $+85^{\circ}C$								
Power Dissipation (P_D)		CD4051BC/CD4052BC/CD4053BC	$-40^{\circ}C$ to $+85^{\circ}C$								
Dual-In-Line	700 mW	Note 1: "Absolute Maximum Ratings" are those values beyond which the safety of the device cannot be guaranteed. Except for "Operating Temperature Range" they are not meant to imply that the devices should be operated at these limits. The Electrical Characteristics tables provide conditions for actual device operation.									
Small Outline	500 mW										
Lead Temperature (T_L) (soldering, 10 seconds)	$260^{\circ}C$										
DC Electrical Characteristics (Note 2)											
Symbol	Parameter	Conditions	$-40^{\circ}C$		$+25^{\circ}$			$+85^{\circ}C$		Units	
			Min	Max	Min	Typ	Max	Min	Max		
Control A, B, C and Inhibit											
I_{IN}	Input Current	$V_{DD} = 15V, V_{EE} = 0V$ $V_{IN} = 0V$		-0.1		-10^{-5}	-0.1		-1.0	μA	
			$V_{DD} = 15V, V_{EE} = 0V$ $V_{IN} = 15V$	0.1		10^{-5}	0.1		1.0	μA	
I_{DD}	Quiescent Device Current	$V_{DD} = 5V$		20			20		150	μA	
		$V_{DD} = 10V$		40			40		300	μA	
		$V_{DD} = 15V$		80			80		600	μA	
Signal Inputs (V_{IS}) and Outputs (V_{OS})											
R_{ON}	"ON" Resistance (Peak for $V_{EE} \leq V_{IS} \leq V_{DD}$)	$R_L = 10 k\Omega$ (any channel selected)	$V_{DD} = 2.5V, V_{EE} = -2.5V$ or $V_{DD} = 5V, V_{EE} = 0V$		850		270	1050		1200	Ω
			$V_{DD} = 5V, V_{EE} = -5V$ or $V_{DD} = 10V, V_{EE} = 0V$		330		120	400		520	Ω
			$V_{DD} = 7.5V, V_{EE} = -7.5V$ or $V_{DD} = 15V, V_{EE} = 0V$		210		80	240		300	Ω

DC Electrical Characteristics (Continued)										
Symbol	Parameter	Conditions	-40°C		+25°			+85°C		Units
			Min	Max	Min	Typ	Max	Min	Max	
ΔR_{ON}	Δ "ON" Resistance Between Any Two Channels	$R_L = 10\text{ k}\Omega$ (any channel selected)	$V_{DD} = 2.5V,$ $V_{EE} = -2.5V$ or $V_{DD} = 5V,$ $V_{EE} = 0V$				10			Ω
		$V_{DD} = 5V$ $V_{EE} = -5V$ or $V_{DD} = 10V,$ $V_{EE} = 0V$				10			Ω	
		$V_{DD} = 7.5V,$ $V_{EE} = -7.5V$ or $V_{DD} = 15V,$ $V_{EE} = 0V$				5			Ω	
	"OFF" Channel Leakage Current, any channel "OFF"	$V_{DD}=7.5V,$ $V_{EE}=-7.5V$ $O/I=\pm 7.5V, I/O=0V$		± 50		± 0.01	± 50		± 500	nA
"OFF" Channel Leakage Current, all channels "OFF" (Common OUT/IN)	Inhibit = 7.5V $V_{DD} = 7.5V,$ $V_{EE} = -7.5V,$ $O/I = 0V$ $I/O = \pm 7.5V$	CD4051		± 200		± 0.08	± 200		± 2000	nA
		D4052		± 200		± 0.04	± 200		± 2000	nA
		CD4053		± 200		± 0.02	± 200		± 2000	nA
Control Inputs A, B, C and Inhibit										
V_{IL}	LOW Level Input Voltage	$V_{EE} = V_{SS}$ $R_L = 1\text{ k}\Omega$ to V_{SS} $I_{IS} < 2\text{ }\mu A$ on all OFF Channels $V_{IS} = V_{DD}$ thru $1\text{ k}\Omega$ $V_{DD} = 5V$ $V_{DD} = 10V$ $V_{DD} = 15V$		1.5 3.0 4.0			1.5 3.0 4.0		1.5 3.0 4.0	V V V
V_{IH}	HIGH Level Input Voltage	$V_{DD} = 5$ $V_{DD} = 10$ $V_{DD} = 15$	3.5 7 11		3.5 7 11			3.5 7 11		V V V
I_{IN}	Input Current	$V_{DD} = 15V,$ $V_{EE} = 0V$ $V_{IN} = 0V$		-0.1		-10^{-5}	-0.1		-1.0	μA
		$V_{DD} = 15V,$ $V_{EE} = 0V$ $V_{IN} = 15V$		0.1		10^{-5}	0.1		1.0	μA
Note 2: All voltages measured with respect to V_{SS} unless otherwise specified.										

AC Electrical Characteristics (Note 3)							
$T_A = 25^\circ\text{C}$, $t_r = t_f = 20\text{ ns}$, unless otherwise specified.							
Symbol	Parameter	Conditions	V_{DD}	Min	Typ	Max	Units
t_{PZH} , t_{PZL}	Propagation Delay Time from Inhibit to Signal Output (channel turning on)	$V_{EE} = V_{SS} = 0V$ $R_L = 1\text{ k}\Omega$ $C_L = 50\text{ pF}$	5V 10V 15V		600 225 160	1200 450 320	ns ns ns
t_{PHZ} , t_{PLZ}	Propagation Delay Time from Inhibit to Signal Output (channel turning off)	$V_{EE} = V_{SS} = 0V$ $R_L = 1\text{ k}\Omega$ $C_L = 50\text{ pF}$	5V 10V 15V		210 100 75	420 200 150	ns ns ns
C_{IN}	Input Capacitance Control input Signal Input (IN/OUT)				5 10	7.5 15	pF pF
C_{OUT}	Output Capacitance (common OUT/IN)						
	CD4051 CD4052 CD4053	$V_{EE} = V_{SS} = 0V$	10V 10V 10V		30 15 8		pF pF pF
C_{IOS}	Feedthrough Capacitance				0.2		pF
C_{PD}	Power Dissipation Capacitance						
	CD4051 CD4052 CD4053				110 140 70		pF pF pF
Signal Inputs (V_{IS}) and Outputs (V_{OS})							
	Sine Wave Response (Distortion)	$R_L = 10\text{ k}\Omega$ $f_{IS} = 1\text{ kHz}$ $V_{IS} = 5\text{ V}_{p-p}$ $V_{EE} = V_{SI} = 0V$	10V		0.04		%
	Frequency Response, Channel "ON" (Sine Wave Input)	$R_L = 1\text{ k}\Omega$, $V_{EE} = 0V$, $V_{IS} = 5V_{p-p}$, $20\log_{10} V_{OS}/V_{IS} = -3\text{ dB}$	10V		40		MHz
	Feedthrough, Channel "OFF"	$R_L = 1\text{ k}\Omega$, $V_{EE} = V_{SS} = 0V$, $V_{IS} = 5V_{p-p}$, $20\log_{10} V_{OS}/V_{IS} = -40\text{ dB}$	10V		10		MHz
	Crosstalk Between Any Two Channels (frequency at 40 dB)	$R_L = 1\text{ k}\Omega$, $V_{EE} = V_{SS} = 0V$, $V_{IS}(A) = 5V_{p-p}$, $20\log_{10} V_{OS}(B)/V_{IS}(A) = -40\text{ dB}$ (Note 4)	10V		3		MHz
t_{PHL} , t_{PLH}	Propagation Delay Signal Input to Signal Output	$V_{EE} = V_{SS} = 0V$ $C_L = 50\text{ pF}$	5V 10V 15V		25 15 10	55 35 25	ns ns ns
Control Inputs, A, B, C and Inhibit							
	Control Input to Signal Crosstalk	$V_{EE} = V_{SS} = 0V$, $R_L = 10\text{ k}\Omega$ at both ends of channel. Input Square Wave Amplitude = 10V	10V		65		mV (peak)
t_{PHL} , t_{PLH}	Propagation Delay Time from Address to Signal Output (channels "ON" or "OFF")	$V_{EE} = V_{SS} = 0V$ $C_L = 50\text{ pF}$	5V 10V 15V		500 180 120	1000 360 240	ns ns ns
Note 3: AC Parameters are guaranteed by DC correlated testing.							
Note 4: A, B are two arbitrary channels with A turned "ON" and B "OFF".							

Special Considerations

In certain applications the external load-resistor current may include both V_{DD} and signal-line components. To avoid drawing V_{DD} current when switch current flows into IN/OUT pin, the voltage drop across the bidirectional

switch must not exceed 0.6V at $T_A \leq 25^\circ\text{C}$, or 0.4V at $T_A > 25^\circ\text{C}$ (calculated from R_{ON} values shown). No V_{DD} current will flow through R_L if the switch current flows into OUT/IN pin.

Typical Performance Characteristics

“ON” Resistance vs Signal Voltage for $T_A = 25^\circ\text{C}$

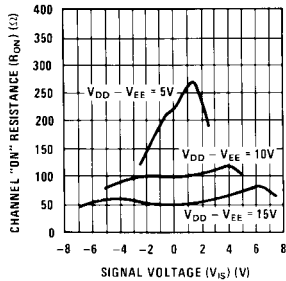

“ON” Resistance as a Function of Temperature for $V_{DD} - V_{EE} = 10\text{V}$

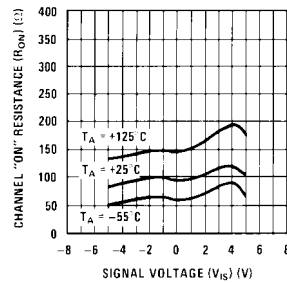

“ON” Resistance as a Function of Temperature for $V_{DD} - V_{EE} = 15\text{V}$

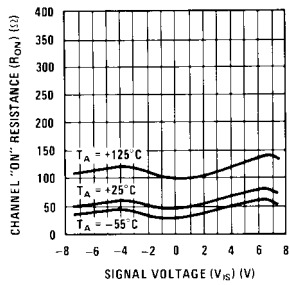

“ON” Resistance as a Function of Temperature for $V_{DD} - V_{EE} = 5\text{V}$

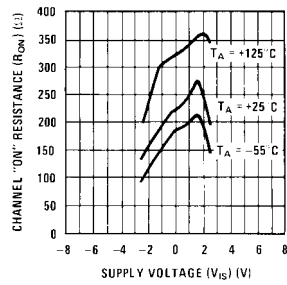

Switching Time Waveforms

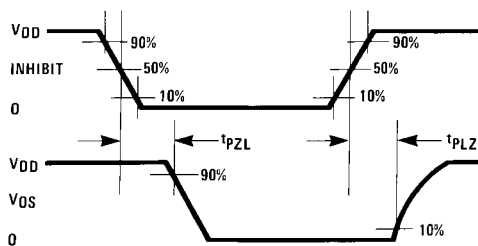
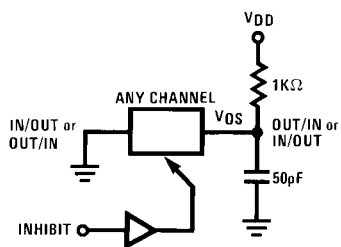
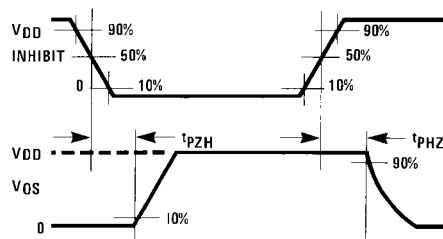
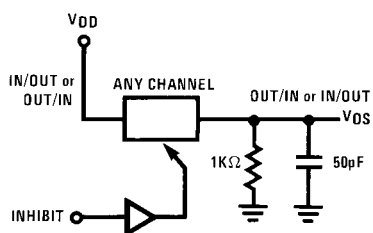
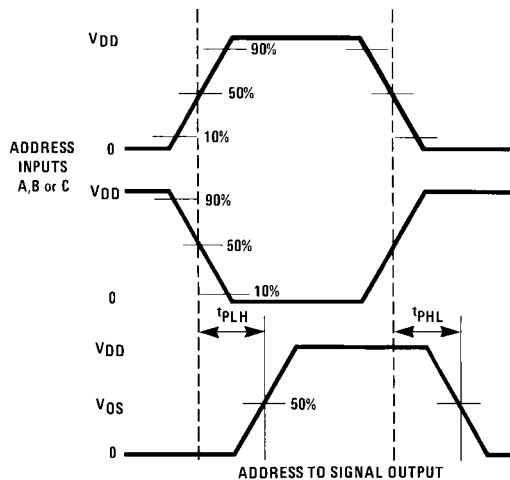
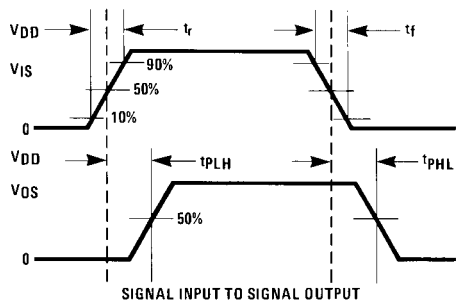

Physical Dimensions inches (millimeters) unless otherwise noted

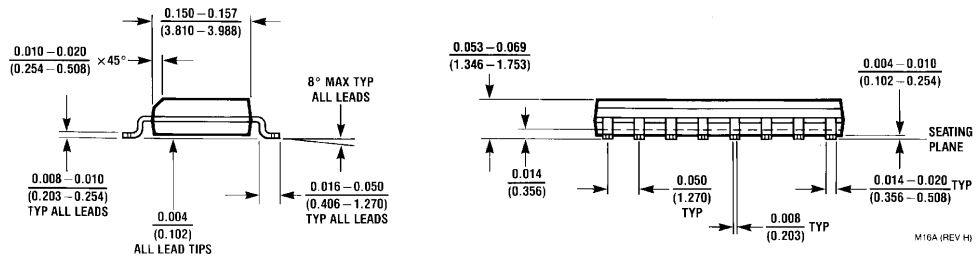
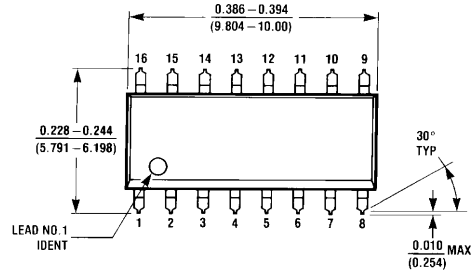

**16-Lead Small Outline Integrated Circuit (SOIC), JEDEC MS-012, 0.150" Narrow Body
Package Number M16A**

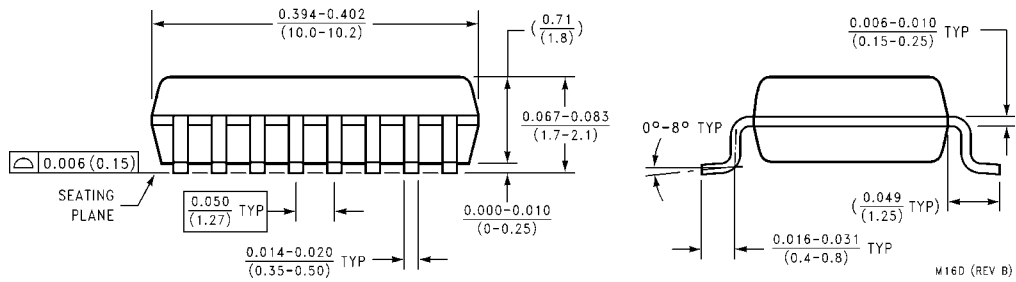
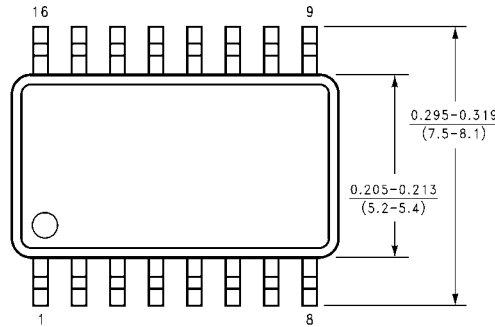

**16-Lead Small Outline Package (SOP), EIAJ TYPE II, 5.3mm Wide
Package Number M16D**

Physical Dimensions inches (millimeters) unless otherwise noted (Continued)

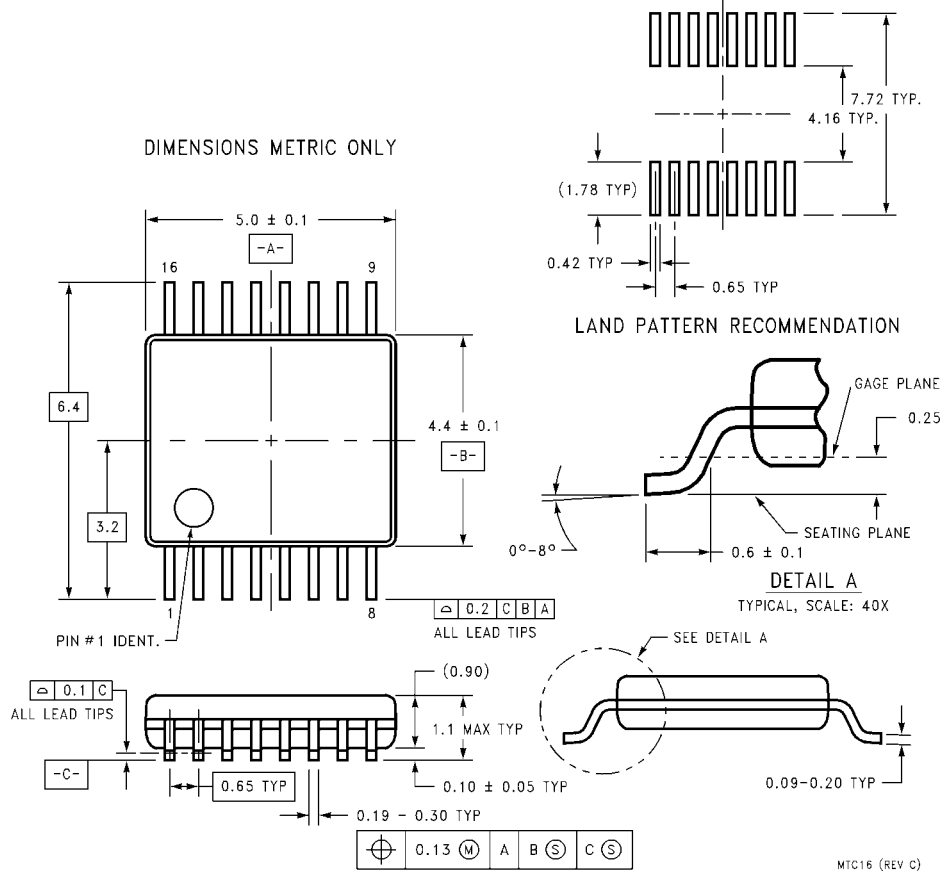

**16-Lead Thin Shrink Small Outline Package (TSSOP), JEDEC MO-153, 4.4mm Wide
Package Number MTC16**

Physical Dimensions inches (millimeters) unless otherwise noted (Continued)

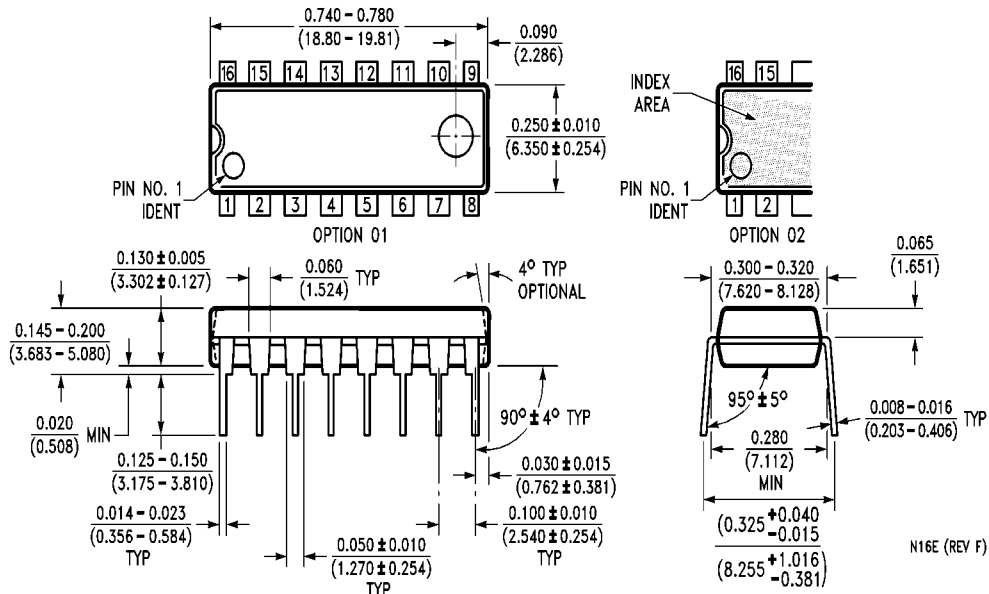

16-Lead Plastic Dual-In-Line Package (PDIP), JEDEC MS-001, 0.300" Wide
Package Number N16E

LIFE SUPPORT POLICY

FAIRCHILD'S PRODUCTS ARE NOT AUTHORIZED FOR USE AS CRITICAL COMPONENTS IN LIFE SUPPORT DEVICES OR SYSTEMS WITHOUT THE EXPRESS WRITTEN APPROVAL OF THE PRESIDENT OF FAIRCHILD SEMICONDUCTOR CORPORATION. As used herein:

1. Life support devices or systems are devices or systems which, (a) are intended for surgical implant into the body, or (b) support or sustain life, and (c) whose failure to perform when properly used in accordance with instructions for use provided in the labeling, can be reasonably expected to result in a significant injury to the user.
2. A critical component in any component of a life support device or system whose failure to perform can be reasonably expected to cause the failure of the life support device or system, or to affect its safety or effectiveness.

www.fairchildsemi.com