

NAIS

GU (General Use) Type [1-Channel (Form B) Type]

PhotoMOS RELAYS

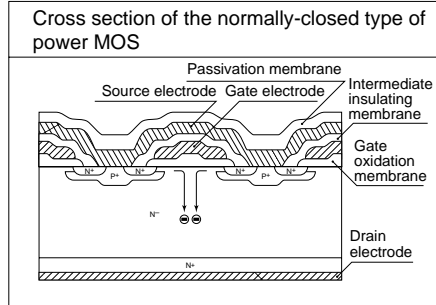
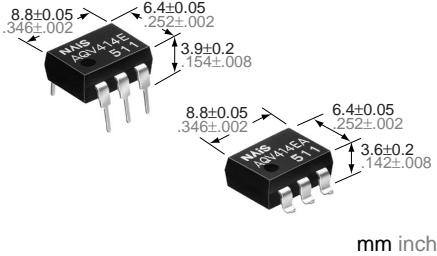

4. Low-level off state leakage current
 The SSR has an off state leakage current of several milliamperes, whereas the PhotoMOS relay has only 100 pA even with the rated load voltage of 400 V.

FEATURES

1. Low on resistance for normally-closed type

This has been realized thanks to the built-in MOSFET processed by our proprietary method, DSD (Double-diffused and Selective Doping) method.

2. Controls low-level analog signals

PhotoMOS relays feature extremely low closed-circuit offset voltage to enable control of low-level analog signals without distortion.

3. High sensitivity, low ON resistance

Can control a maximum 0.15 A load current with a 5 mA input current.

TYPICAL APPLICATIONS

- Telephone equipment (Dial pulse)
- Measuring equipment

TYPES

Type	I/O isolation voltage	Output rating*		Part No.				Packing quantity	
				Through hole terminal	Surface-mount terminal				
		Load voltage	Load current		Tube packing style		Tape and reel packing style		Tube
AC/DC type	1,500 V AC	400 V	120 mA	AQV414	AQV414A	Picked from the 1/2/3-pin side	Picked from the 4/5/6-pin side	1 tube contains 50 pcs. 1 batch contains 500 pcs.	

*Indicate the peak AC and DC values.

Note: For space reasons, the package type indicator "X" and "Z" are omitted from the seal.

RATING

1. Absolute maximum ratings (Ambient temperature: 25°C 77°F)

Item		Symbol	Type of connection	AQV414(A)	Remarks	
Input	LED forward current	I_F		50 mA	$f = 100 \text{ Hz, Duty factor} = 0.1\%$	
	LED reverse voltage	V_R		3 V		
	Peak forward current	I_{FP}		1 A		
	Power dissipation	P_{in}		75 mW		
Output	Load voltage (peak AC)	V_L		400 V	A connection: Peak AC, DC B,C connection: DC	
	Continuous load current	I_L		A		0.12 A
				B		0.13 A
				C		0.15 A
	Peak load current	I_{peak}				0.3 A
Power dissipation	P_{out}		500 mW			
Total power dissipation		P_T		550 mW		
I/O isolation voltage		V_{iso}		1,500 V AC		
Temperature limits	Operating	T_{opr}		-40°C to +85°C -40°F to +185°F	Non-condensing at low temperatures	
	Storage	T_{stg}		-40°C to +100°C -40°F to +212°F		

AQV414

2. Electrical characteristics (Ambient temperature: 25°C 77°F)

Item			Symbol	Type of connection	AQV414(A)	Condition	
Input	LED operate (OFF) current	Typical	I_{Foff}	—	1.0 mA	$I_L = 120 \text{ mA}$	
		Maximum			3.0 mA		
	LED reverse (ON) current	Minimum	I_{Fon}	—	0.4 mA	$I_L = 120 \text{ mA}$	
		Typical			0.95 mA		
	LED dropout voltage	Typical	V_F	—	1.14 V (1.25 V at $I_F = 50 \text{ mA}$)	$I_F = 5 \text{ mA}$	
		Maximum			1.5 V		
Output	On resistance	Typical	R_{on}	A	26 Ω	$I_F = 0 \text{ mA}$ $I_L = 120 \text{ mA}$ Within 1 s on time	
		Maximum			50 Ω		
		Typical	R_{on}	B	20 Ω		
		Maximum			25 Ω		
	Typical	R_{on}	C	10 Ω	$I_F = 0 \text{ mA}$ $I_L = 120 \text{ mA}$ Within 1 s on time		
	Maximum			12.5 Ω			
	Off state leakage current	Maximum	I_{Leak}	—		1 μA	$I_F = 5 \text{ mA}$ $V_L = 400 \text{ V}$
	Transfer characteristics	Switching speed	Operate (OFF) time*	T_{off}		—	0.47 ms
Maximum					1.0 ms		
Reverse (ON) time*			T_{on}	—	0.28 ms	$I_F = 5 \text{ mA} \rightarrow 0 \text{ mA}$ $I_L = 120 \text{ mA}$	
					Maximum		1.0 ms
I/O capacitance		Typical	C_{iso}	—	0.8 pF	$f = 1 \text{ MHz}$ $V_B = 0$	
		Maximum			1.5 pF		
Initial I/O isolation resistance	Minimum	R_{iso}	—	1,000 M Ω	500 V DC		

Note: Recommendable LED forward current $I_F = 5 \text{ mA}$.

For type of connection, see Page 445.

*Operate/Reverse time

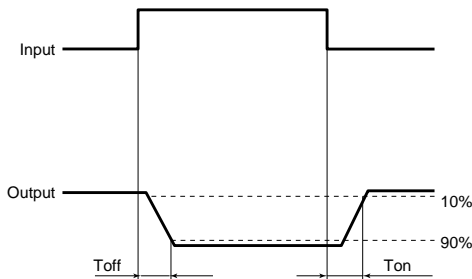

- For Dimensions, see Page 440.
- For Schematic and Wiring Diagrams, see Page 445.
- For Cautions for Use, see Page 449.

REFERENCE DATA

1. Load current vs. ambient temperature characteristics

Allowable ambient temperature: -40°C to $+85^\circ\text{C}$
 -40°F to $+185^\circ\text{F}$

Type of connection: A

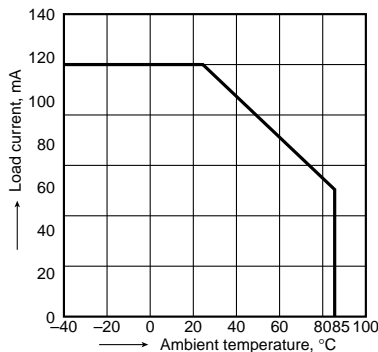

2. On resistance vs. ambient temperature characteristics

Measured portion: between terminals 4 and 6;
LED current: 0 mA;
Continuous load current: 120 mA (DC)

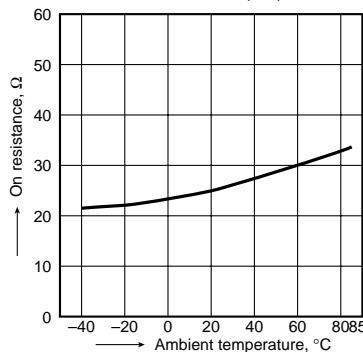

3. Operate (OFF) time vs. ambient temperature characteristics

LED current: 5 mA;
Load voltage: 400 V (DC);
Continuous load current: 120 mA (DC)

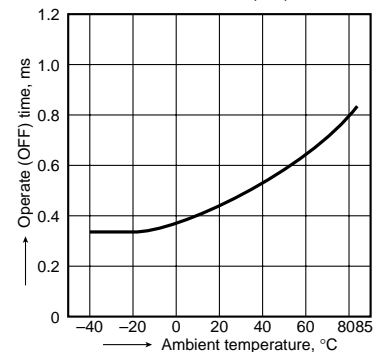

4. Reverse (ON) time vs. ambient temperature characteristics

LED current: 5 mA; Load voltage: 400 V (DC);
Continuous load current: 120 mA (DC)

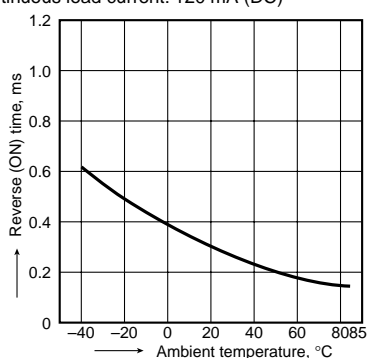

5. LED operate (OFF) current vs. ambient temperature characteristics

Load voltage: 400 V (DC);
Continuous load current: 120 mA (DC)

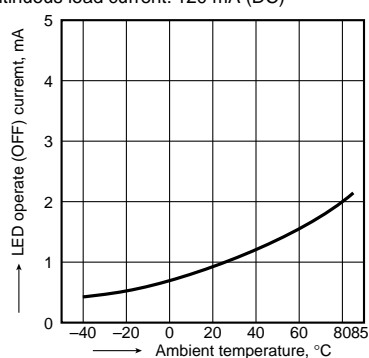

6. LED reverse (ON) current vs. ambient temperature characteristics

Load voltage: 400 V (DC);
Continuous load current: 120 mA (DC)

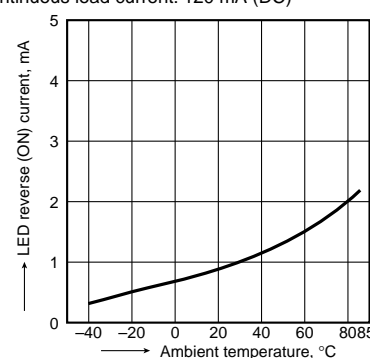

7. LED dropout voltage vs. ambient temperature characteristics

LED current: 5 to 50 mA

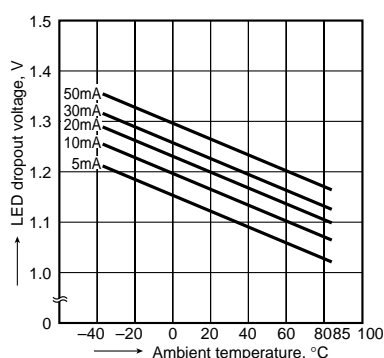

8. Voltage vs. current characteristics of output at MOS portion

Measured portion: between terminals 4 and 6;
Ambient temperature: 25°C 77°F

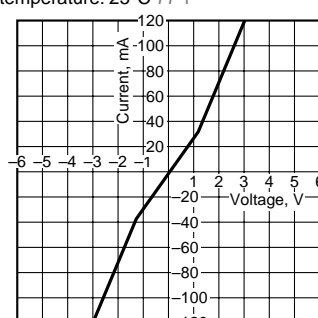

9. Off state leakage current

Measured portion: between terminals 4 and 6;
LED current: 5 mA; Ambient temperature: 25°C 77°F

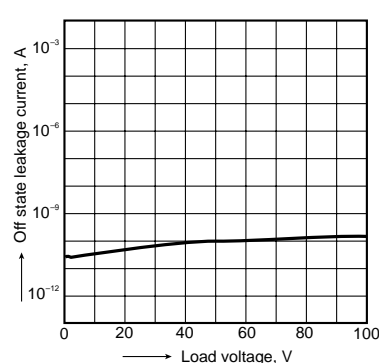

10. LED forward current vs. operate (OFF) time characteristics

Measured portion: between terminals 4 and 6;
Load voltage: 400 V (DC);
Continuous load current: 120 mA (DC);
Ambient temperature: 25°C 77°F

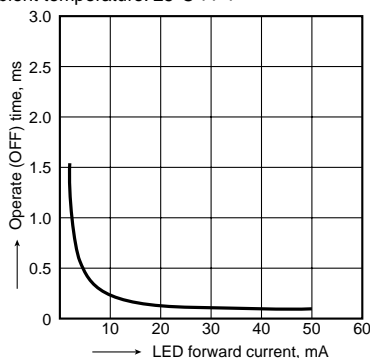

11. LED forward current vs. reverse (ON) time characteristics

Measured portion: between terminals 4 and 6;
Load voltage: 400 V (DC);
Continuous load current: 120 mA (DC);
Ambient temperature: 25°C 77°F

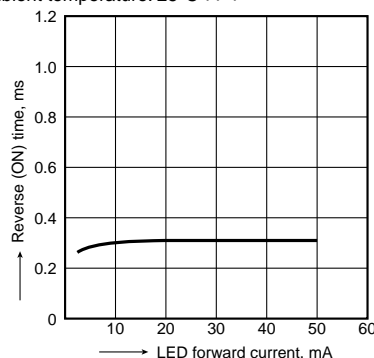

12. Applied voltage vs. output capacitance characteristics

Measured portion: between terminals 4 and 6;
Frequency: 1 MHz; Ambient temperature: 25°C 77°F

