

NAIS

MINIATURE RELAY FOR WIDER APPLICATIONS

HC-RELAYS

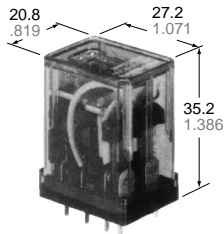
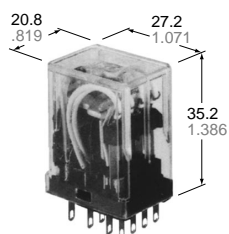

HCE Amber Relays

mm inch

FEATURES

- **Extra long life — Min. 10⁸ mechanical operations (DC type)**
- **4 contact arrangements**
4 Form C (for 5 A 250 V AC),
3 Form C (for 7 A 250 V AC),
2 Form C (for 7 A 250 V AC),
1 Form C (for 10 A 250 V AC)
- **Applicable to low to high level loads (100µA to 10A)**
- **Amber sealed types available**
- **Bifurcated contact types available as HC4D**

SPECIFICATIONS

Contacts

Arrangement		1 Form C	2 Form C	3 Form C	4 Form C
Initial current resistance, max. (By voltage drop 6 V DC 1 A)		30 mΩ			
Contact material		Gold-flashed silver alloy			Gold-clad silver nickel
Rating (resistive)	Nominal switching capacity	10 A 250 V AC	7 A 250 V AC	7 A 250 V AC	5 A 250 V AC
	Max. switching power	2,500 VA	1,750 VA	1,750 VA	1,250 VA
	Max. switching voltage	250 V AC			
	Max. switching current	10 A	7 A	7 A	5 A

Coil

Nominal operating power	AC (50Hz): 1.3VA, AC (60Hz): 1.2 VA DC: 0.9 to 1.1W
-------------------------	--

Remarks

- * Specifications will vary with foreign standards certification ratings.
- *1 Detection current: 10 mA
- *2 Excluding contact bounce time
- *3 Half-wave pulse of sine wave: 11ms; detection time: 10µs
- *4 Half-wave pulse of sine wave: 6ms
- *5 Detection time: 10µs
- *6 Refer to 5. Conditions for operation, transport and storage mentioned in AMBIENT ENVIRONMENT (Page 61).

Characteristics

Max. operating speed		20 cpm (at max. rating)
Initial insulation resistance		Min. 1,000 MW at 500 V DC
Initial breakdown voltage*1	Between open contacts	700 Vrms for 1 min.
	Between contact sets	700 Vrms for 1 min.
	Between contact and coil	2,000 Vrms for 1 min.
Operate time*2 (at nominal voltage) (at 20°C)		Approx. 10 ms (DC, AC type)
Release time (without diode)*2 (at nominal voltage) (at 20°C)		Approx. 5 ms (DC type) Approx. 10 ms (AC type)
Temperature rise, max. (at 70°C) (at nominal voltage)		80°C
Shock resistance	Functional*3	Min. 196 m/s ² {20 G}
	Destructive*4	Min. 980 m/s ² {100 G}
Vibration resistance	Functional*5	10 to 55 Hz at double amplitude of 1 mm
	Destructive	10 to 55 Hz at double amplitude of 2 mm
Conditions for operation, transport and storage*6 (Not freezing and condensing at low temperature)	Ambient temp.	-50°C to +70°C -58°F to +158°F
	Humidity	5 to 85% R.H.
Unit weight		Approx. 30g 1.06 oz

Expected life (min. operations)

Electrical (at 20 cpm)

Voltage		125 V AC		250 V AC		30 V DC		Expected life
Load		Resistive (cos φ = 1)	Inductive (cos φ ≐ 0.4)	Resistive (cos φ = 1)	Inductive (cos φ ≐ 0.4)	Resistive	Inductive	
HC1 (1 Form C)	Current	10A	5A	10A	3A	—	—	2×10 ⁵
		7A	3A	7A	2.5A	3A	1A	5×10 ⁵
		5A	2A	5A	1.5A	—	—	1×10 ⁶
HC2 (2 Form C)	Current	7A	3.5A	7A	2A	—	—	2×10 ⁵
		5A	2.5A	5A	1.5A	3A	0.6A	5×10 ⁵
		3A	1.5A	3A	1A	—	—	1×10 ⁶
HC3 (3 Form C)	Current	7A	—	7A	—	—	—	1×10 ⁵
		—	3.5A	—	2A	—	—	2×10 ⁵
		5A	—	5A	—	3A	0.4A	5×10 ⁵
HC4 (4 Form C)	Current	5A	2A	5A	1A	—	—	2×10 ⁵
		3A	1A	3A	0.8A	3A	0.4A	5×10 ⁵
		2A	0.5A	2A	0.4A	—	—	1×10 ⁶

Mechanical life (at 180 cpm)

DC type: 10⁸, AC type: 5×10⁷

TYPICAL APPLICATIONS

Transportation, power station control equipment, refrigerators, building control equipment, office machines, coin operat-

ed machines, amusement devices, medical equipment, etc.

ORDERING INFORMATION

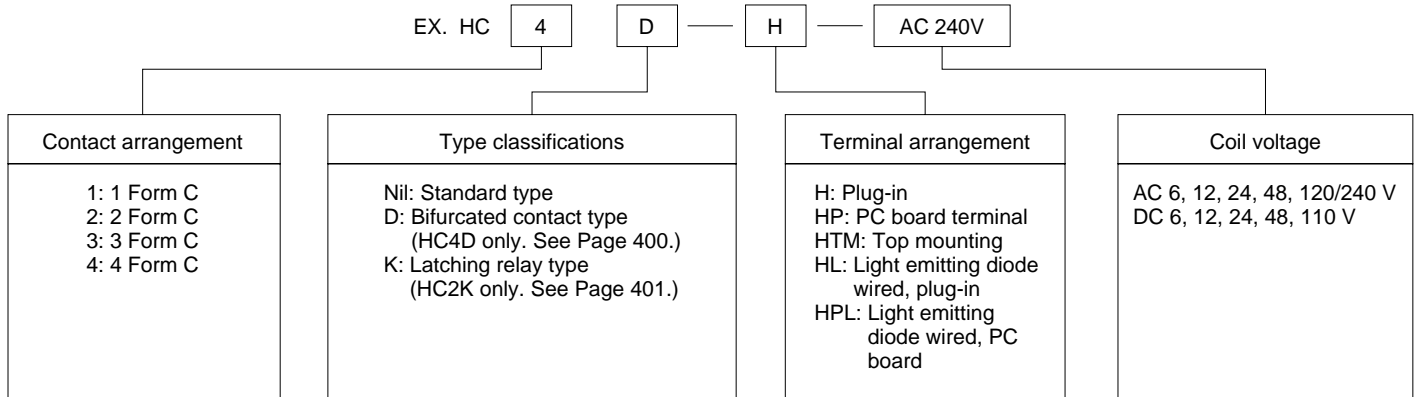

Notes:

1. When ordering VDE recognized types, add suffix VDE.
2. HC3 (3 Form C) series are not approved by VDE.
3. AC 48 V type is not available for LED wiring.
4. Standard packing Carton: 20 pcs.; Case: 200 pcs.
5. UL/CSA approved type is standard.

COIL DATA (Common for Standard, Amber sealed and Bifurcated contact types)

DC Type at 20°C 68°F

Coil voltage, V DC	Pick-up voltage, V DC (max.)	Drop-out voltage, V DC (min.)	Max. allowable voltage, V DC	Coil resistance, Ω (±10%)	Nominal coil current, mA (±10%)	Operating power, W	
						Nominal	Minimum
6	4.8	0.6	6.6	40	150	0.9	0.58
12	9.6	1.2	13.2	160	75	0.9	0.58
24	19.2	2.4	26.4	650	37	0.9	0.58
48	38.4	4.8	52.8	2,600	18.5	0.9	0.58
110	88.0	11.0	121.0	10,000	10	1.0	0.64

AC Types (50/60 Hz) at 60 Hz, 20°C 68°F

Coil voltage, V AC	Pick-up voltage, V AC (max.)	Drop-out voltage, V AC (min.)	Max. allowable voltage, V AC	Nominal coil current, mA (±20%)	Operating power, VA	
					Nominal	Minimum
6	4.8	1.8	6.6	200	1.20	0.77
12	9.6	3.6	13.2	100		
24	19.2	7.2	26.4	50		
48	38.4	14.4	52.8	25		
110/120	96	36	132	10.9/11.9		
220/240	176.0	66.0	264.0	6.0/6.5		

NOTES:

1. The range of coil current is ±15% for AC (60 Hz), and ±10% for DC, at 20°C.
 2. The relay is applicable to the range of 80 % to 110% of the nominal coil voltage. However, it is recommended that the relay be used in the range of 85% to 110% to take temporary voltage variations into consideration.

3. The coil resistance of DC types is the measured value at a coil temperature of 20°C. Please compensate coil resistance by ±0.4% for each degree centigrade coil temperature change.
 4. All AC 240 V types are rated for double coil voltages, both AC 220 V and AC 240 V.

5. For use with 220 V or 240 V DC, connect a resistor as suggested in the chart below, in series with the 110 V DC relay.

Voltage	1 Form C, 2 Form C, 3 Form C, 4 Form C
220 V DC	11 kΩ (5 W)
240 V DC	13 kΩ (5 W)

DIMENSIONS (Common for standard, Amber sealed and Bifurcated contact (4C only) types)

Plug-in type

HC1-H (1 Form C)

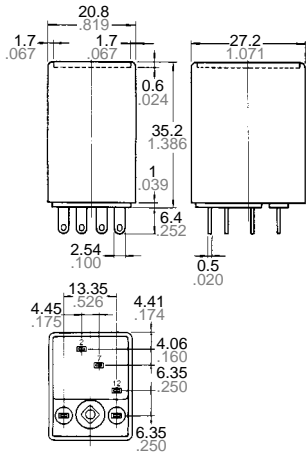

HC2-H (2 Form C)

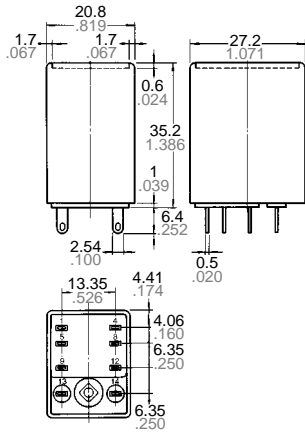

HC3-H (3 Form C)

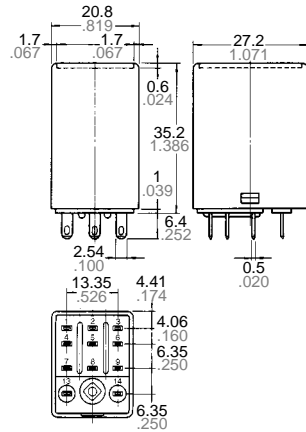

HC4-H (4 Form C)

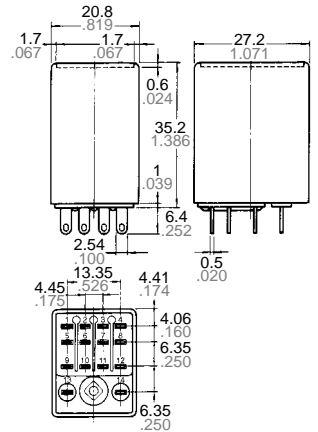

General tolerance: $\pm 0.2 \pm .008$

PC board type

HC4-H (4 Form C)

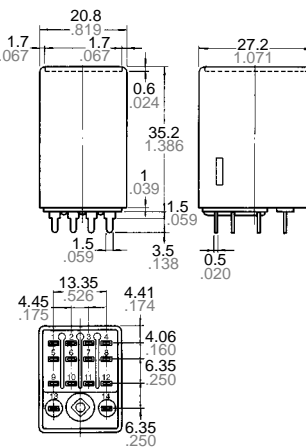

Dimensions of HC1-HP, HC2-HP, HC3-HP are the same as those of plug-in type except shapes of terminals.

PC board pattern (Copper-side view)

1c

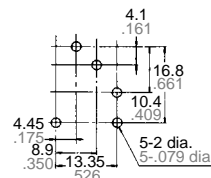

2c

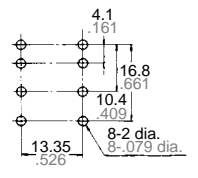

3c

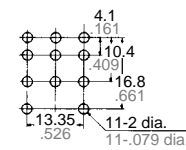

4c

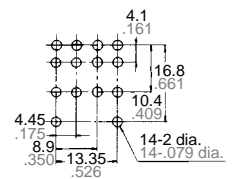

Tolerance: $\pm 0.1 \pm .004$

General tolerance: $\pm 0.2 \pm .008$

Note: Special PC terminal with 0.9 mm (.035 inch) width available with suffix "-31".

Schematic (bottom view)

HC1-H, HC1-HP (1 Form C)

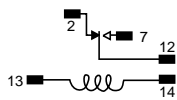

LED AC type

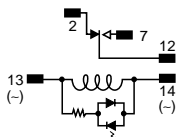

LED DC type

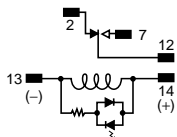

HC2-H, HC2-HP (2 Form C)

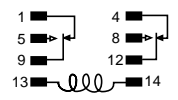

LED AC type

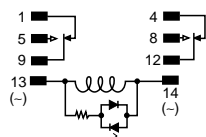

LED DC type

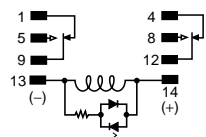

HC3-H, HC3-HP (3 Form C)

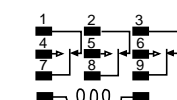

LED AC type

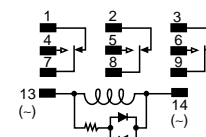

LED DC type

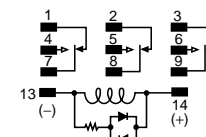

HC4-H, HC4-HP (4 Form C)

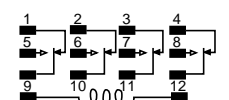

LED AC type

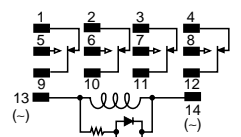

LED DC type

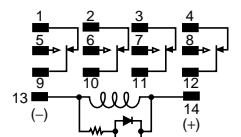

REFERENCE DATA

1. Life curve

Load: 250 V AC resistive load

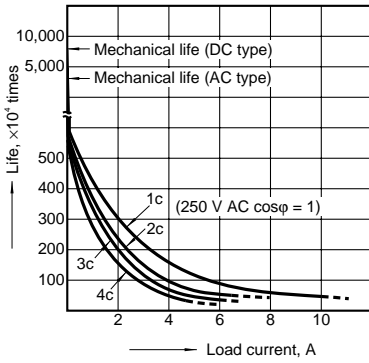

2. Switching capacity range

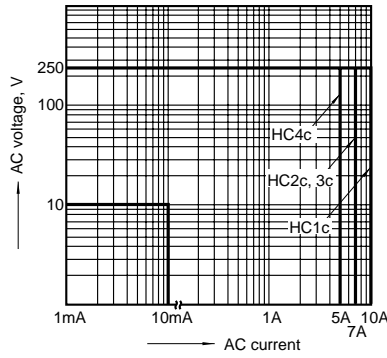

3. H₂S gas test

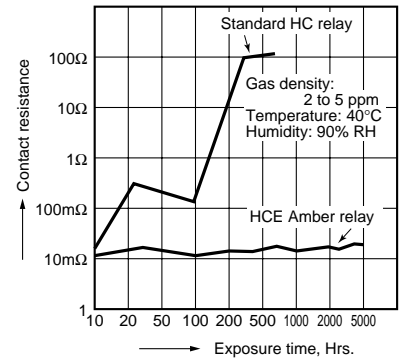

4. Coil temperature rise

Measured portion: Inside the coil Note: When the nominal voltage is applied to AC 120 or 240 V coil types respectively, the figures of coil temperature rise increase by approx. 10 degrees to the ones shown on each graph.

HC1 AC coil

Ambient temperature: 25°C 77°F

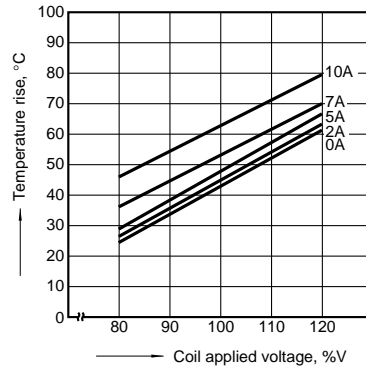

HC2 AC coil

Ambient temperature: 30°C 86°F

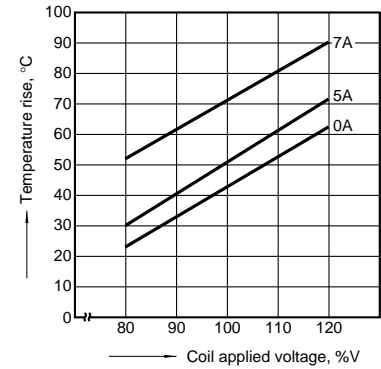

HC3 AC coil

Ambient temperature: 18°C 64°F

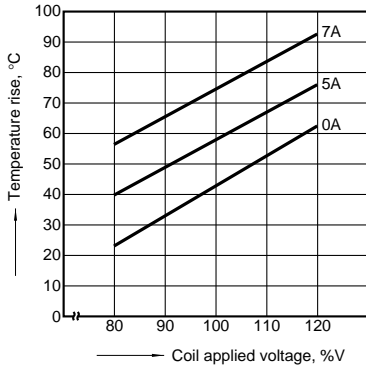

HC4 AC coil

Ambient temperature: 15 to 21°C 59 to 70°F

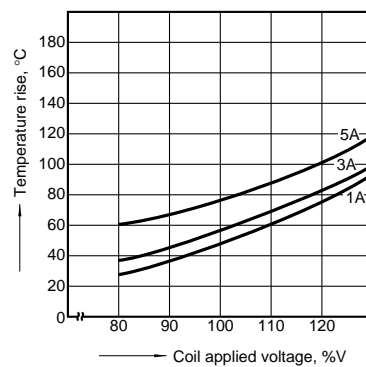

HC1 DC coil

Ambient temperature: 29°C 84°F

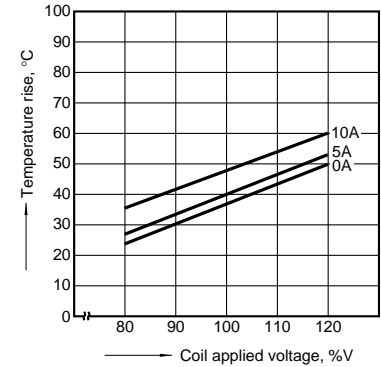

HC2 DC coil

Ambient temperature: 29°C 84°F

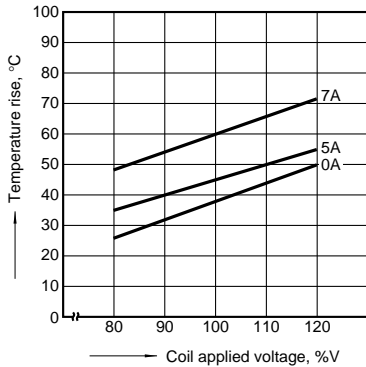

HC3 DC coil

Ambient temperature: 29°C 84°F

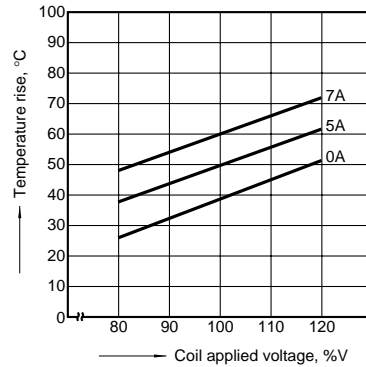

HC4 DC coil

Ambient temperature: 17 to 18°C 62 to 64°F

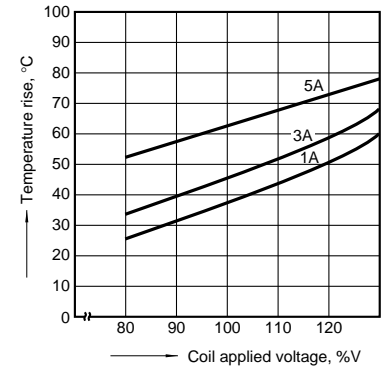

Amber Relays HCE

HC sealed relays are version of the HC relays and are recommended for use in switching medium loads under adverse ambient conditions. They show highly stable contact resistance even after long use, due to their sealed construction and reliable gold plated contacts. Amber relays also make the combined process of automatic wave soldering and cleaning process possible with their resultant savings

in cost and labor. Contact arrangements of 1 Form C, 2C, and 4C are available for plug-in, PC board and top-mount.

Construction

The diagram at right shows a cross-section of the plastic sealed relay. All the plastic parts are annealed and out-gassed to ensure fully the stability of both chemical and physical characteristics.

Sealed construction

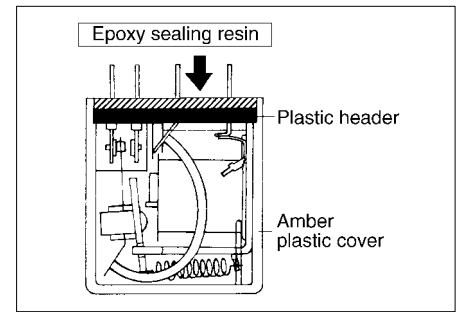

SPECIFICATIONS

Contacts

Contact arrangement		1 Form C	2 Form C	4 Form C
Rating (resistive)	Nominal switching capacity	5 A 250 V AC	3 A 250 V AC	2 A 250 V AC
	Max. switching power	1,250 VA	700 VA	500 VA
	Max. switching voltage	250 V AC		
	Max. switching current	5 A	3 A	2 A
Conditions for operation, transport and storage (Not freezing and condensing at low temperature)		Ambient temp. -40°C to +60°C -40°F to +140°F		
		Humidity 5 to 85% R.H.		
Ambient air pressure		760 mmHg +20% (1.013 mb +20%)		

Expected life (min. operations)

Electrical (at 20 cpm)	Voltage		125 V AC	250 V AC	30 V DC		Expected life
	Load		Resistive (cos φ = 1)	Resistive (cos φ = 1)	Resistive	Inductive	
	HC1E (1 Form C)	Current	5 A	5 A	3 A	1 A	
HC2E (2 Form C)	Current	3 A	3 A	2 A	1.7 A		
HC4E (4 Form C)	Current	2 A	2 A	2 A	0.6 A		
Mechanical life (at 180 cpm)	DC type: 10 ⁸ , AC type: 5×10 ⁷						

Characteristics

Operate time	Approx. 10 ms (DC, AC type)
Release time	Approx. 5 ms (DC type) Approx. 10 ms (AC type)

ORDERING INFORMATION

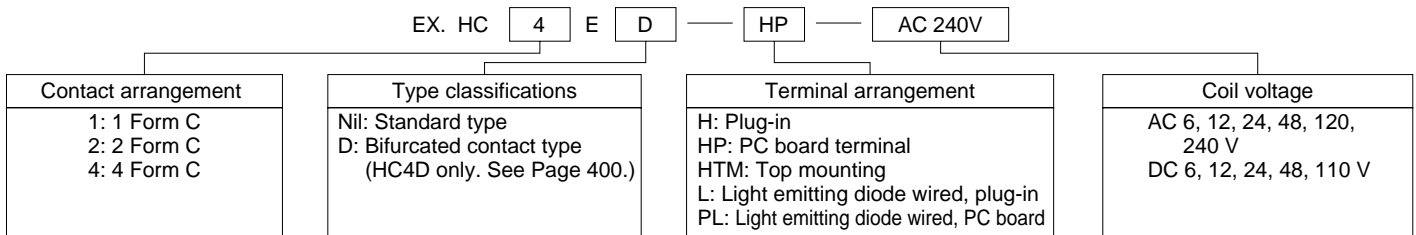

UL/CSA approved type is standard.

REFERENCE DATA (HC Amber Relays)

1. Switching capacity range

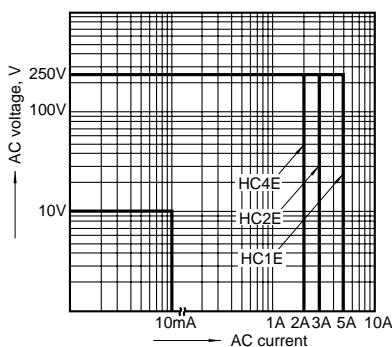

2.-(1) Coil temperature rise (1c AC type)

Measured portion: Inside the coil
Ambient temperature 30°C 86°F

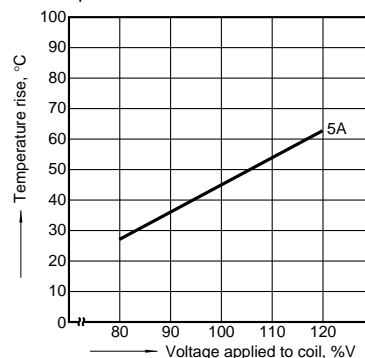

2.-(2) Coil temperature rise (2c AC type)

Measured portion: Inside the coil
Ambient temperature: 30°C 86°F

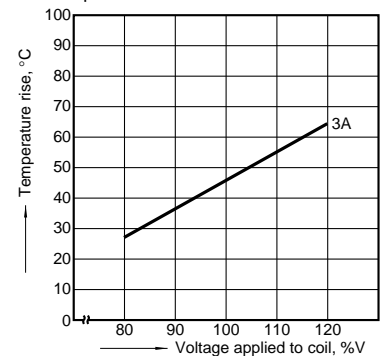

2.-(3) Coil temperature rise (4c AC type)

Measured portion: Inside the coil
Ambient temperature: 30°C 86°F

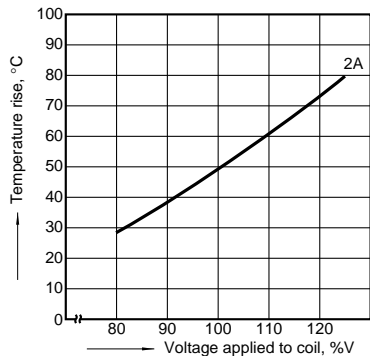

2.-(4) Coil temperature rise (1c DC type)

Measured portion: Inside the coil
Ambient temperature: 30°C 86°F

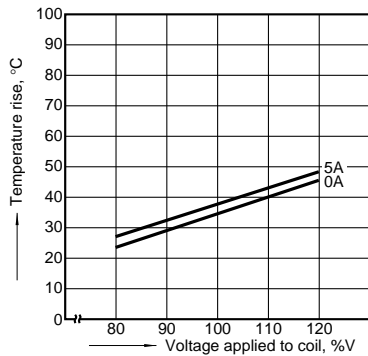

2.-(5) Coil temperature rise (2c DC type)

Measured portion: Inside the coil
Ambient temperature: 30°C 86°F

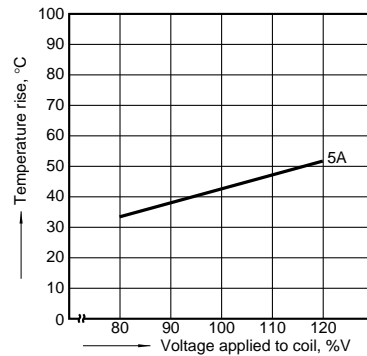

Bifurcated contact types HC4D

Extremely high contact reliability has been made possible by adoption of gold-clad bifurcated contacts for both movable and stationary contacts.

HC4D type can be used from the dry circuit 100 μ A at 10 V DC to the power circuit 3 A at 250 V AC resistive load.

Therefore, with HC4D type such a usage is possible that one contact switches 100 μ A and another contact switches 3 A load. Also Amber sealed types are available as HC4ED relays.

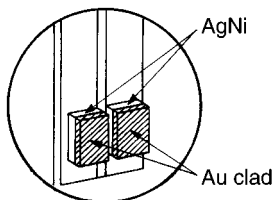

SPECIFICATIONS

Contacts

Contact arrangement	4 Form C only	
Contact material	Gold-clad silver nickel	
Rating (resistive)	Nominal switching capacity	3 A 250 V AC
	Max. switching power	750 VA
	Max. switching current	3A

Characteristics

Operate time (Approx.)	DC, AC: 10 ms
Release time (Approx.)	DC: 5 ms AC: 10 ms

Expected life (min. operations)

Electrical (at 20 cpm)

Voltage	125 V AC		250 V AC		30 V DC	Expected life
	Resistive (cos ϕ = 1)	Inductive (cos ϕ \approx 0.4)	Resistive (cos ϕ = 1)	Inductive (cos ϕ \approx 0.4)		
HC4DE	3 A	1 A	3 A	0.8 A	3 A	2 \times 10 ⁵
HC4ED	1 A	—	1 A	—	—	

REFERENCE DATA

1. Switching capacity range

Standard type

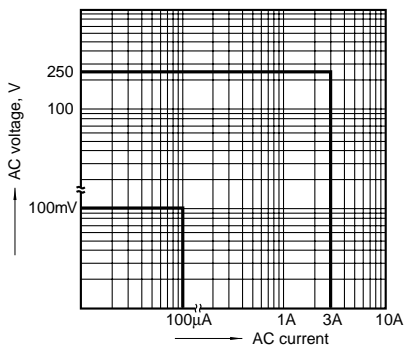

Amber type

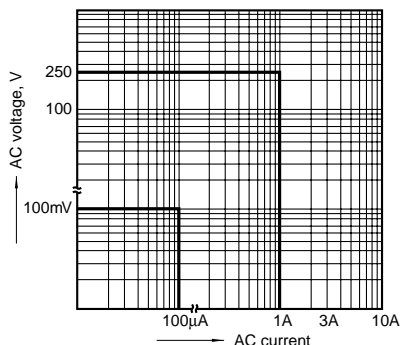

Latching relay types: HC2K

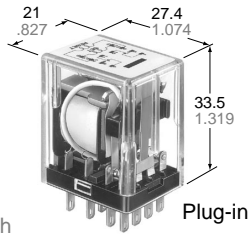

HC magnetic latching relays are particularly suitable for various vending machines, remote control devices, parking meters, conveyor, NC machinery, etc.

TYPES AND COIL DATA

DC coils at 20°C 68°F

UL, CSA recognized

Part No.		Nominal coil current (mA)		Nominal operating power (VA)		Coil voltage	
Plug-in	PC board terminal	set	reset	set	reset	Pick-up	Max. allowable
HC2K-DC6V	HC2K-P-DC6V	207	107	1.24	0.64	80% of Nominal voltage	110% of Nominal voltage
HC2K-DC12V	HC2K-P-DC12V	100	52.2	1.20	0.63		
HC2K-DC24V	HC2K-P-DC24V	51.1	25.5	1.23	0.61		
HC2K-DC48V	HC2K-P-DC48V	25.3	13.7	1.21	0.66		
HC2K-DC100V	HC2K-P-DC100V	15.6	5.8	1.56	0.58		



Plug-in

AC coils

Part No.		Nominal coil current (mA)		Nominal operating power (VA)		Coil voltage	
Plug-in	PC board terminal	set	reset	set	reset	Pick-up	Max. allowable
HC2K-AC6V	HC2K-P-AC6V	206	103	1.23	0.62	80% of Nominal voltage	110% of Nominal voltage
HC2K-AC12V	HC2K-P-AC12V	100	52	1.20	0.62		
HC2K-AC24V	HC2K-P-AC24V	51	21.4	1.22	0.51		
HC2K-AC48V	HC2K-P-AC48V	25.2	18.5	1.2	0.88		
HC2K-AC115V	HC2K-P-AC115V	10.4	5.4	1.20	0.621		



PC board terminal

HC2K AC types are not recognized by UL, CSA.

Notes: 1. The coil current range is $\pm 10\%$ of the nominal coil current.

2. The relay is suitable to the range of 80% — 110% of the nominal coil voltage. However, it is recommended that the relay be used in the range of 85% — 110% of the nominal coil voltage, with the temporary voltage variation taken into consideration.

3. UL/CSA approved type is standard.

SPECIFICATIONS

Contacts

Arrangement	2 Form C only	
Initial contact resistance max. (By voltage drop 6 V DC 1 A)	50 m Ω	
Rating (resistive)	Nominal switching capacity	3 A 250 V AC
	Max. switching power	750 VA
	Max. switching current	3A

Coil

Nominal operating power	Set coil	1.2 VA to 1.33 VA
	Reset coil	0.51 VA to 0.88 VA

Characteristics

Initial breakdown voltage	Between contact and coil	1,500 Vrms for 1 min.
Set time (at nominal voltage) (at 20°C)	AC, DC: Approx. 20 ms	
Reset time (at nominal voltage)	AC: Approx. 30 ms DC: Approx. 50 ms	
Temperature rise (at nominal voltage)	Set coil	Max. 80°C
	Reset coil	Max. 50°C
Shock/vibration resistance	Min. 98 m/s ² {10 G}	
Expected life (min. operations)	Mechanical (at 180 cpm)	10 ⁷
	Electrical (resistive) (at 20 cpm)	2 \times 10 ⁵
Ambient temperature	-40°C to +50°C -40°F to +122°F (Not freezing and condensing at low temperature)	

DIMENSIONS AND CIRCUIT DIAGRAM

mm inch

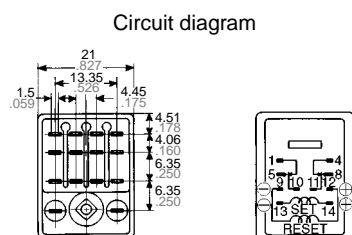
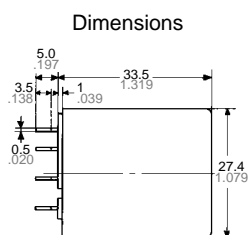

General tolerance: $\pm 0.5 \pm 0.020$

PC board pattern (Copper-side)

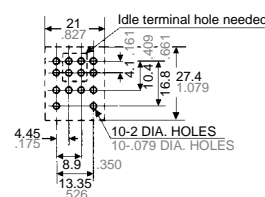

Tolerance: $\pm 0.1 \pm 0.004$

Notes:

1. Configuration and dimensions of HC2K types are the same as those of standard HC4 types. Standard sockets and screw terminal sockets of HC4 can be used: HC4-SS-K, HC4-PS-K, HC4-WS-K, and HC4-HSF-K.

2. Please note that circuit diagram of HC2K is different from HC4.

3. Avoid operation by capacitor since latching force varies according to input pulse voltage.

HC





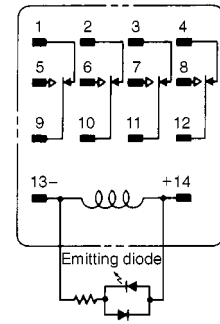
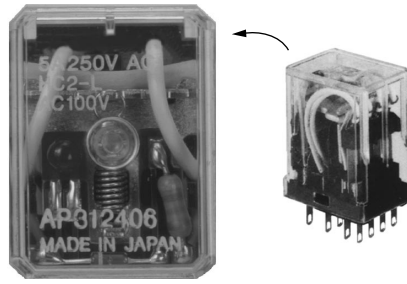







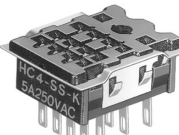



LED wired types: HC-L

The built-in indication LED (Light emitting diode) Series are suitable for instant indication of operate function in applications where numerous relays are to be used. The HC-L relays are supplied with LED wired in parallel with the coil for visual indication that the relay is functioning. A Red LED is used for AC type and green one for DC.

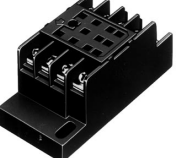
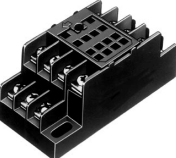

Protection diode
(BOTTOM VIEW)

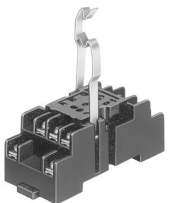
ACCESSORIES

Relay	HC1 (1 Form C)	HC2 (2 Form C)	HC3 (3 Form C)	HC4 (4 Form C)
Socket				
Socket with solder tab (with hold-down clip)	 HC1-SS-K	 HC2-SS-K	 HC3-SS-K	 HC4-SS-K
PC board socket (with hold-down clip)	 HC1-PS-K	 HC2-PS-K	 HC3-PS-K	 HC4-PS-K
Socket for wrap wiring (with hold-down clip)	 HC1-WS-K	 HC2-WS-K	 HC3-WS-K	 HC4-WS-K
Screw terminal socket for front wiring (with hold-down clip)	—	 HC2-SF-K Exclusively for HC2-H	 HC3-HSF-K For HC2-H, HC3-H	 HC4-HSF-K For HC1-H, HC2-H, HC4-H
Screw terminal socket for DIN rail assembly (with hold-down clip)	—	 HC2-SFD-K Exclusively for HC2-H	 HC3-SFD-K For HC2-H, HC3-H	 HC4-SFD-K For HC1-H, HC2-H, HC4-H

DIMENSIONS

Socket with solder tab (with hold-down clip)

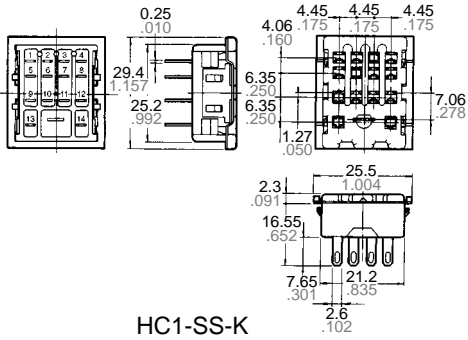

HC1-SS-K

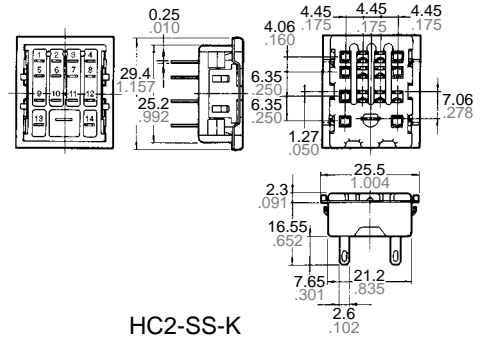

HC2-SS-K

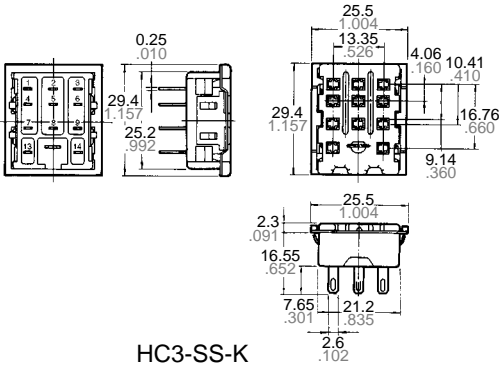

HC3-SS-K

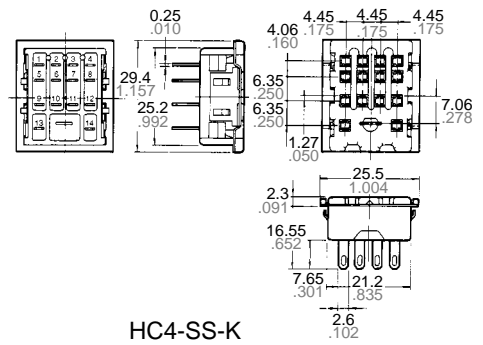

HC4-SS-K

PC board socket (with hold-down clip)

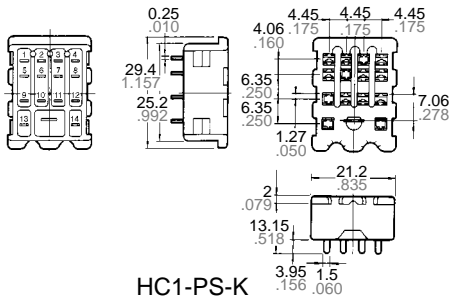

HC1-PS-K

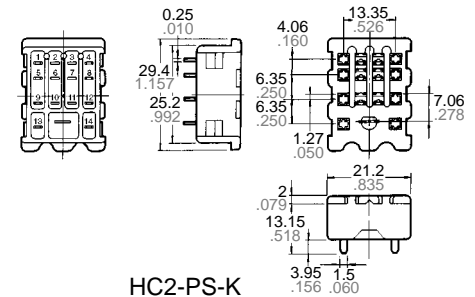

HC2-PS-K

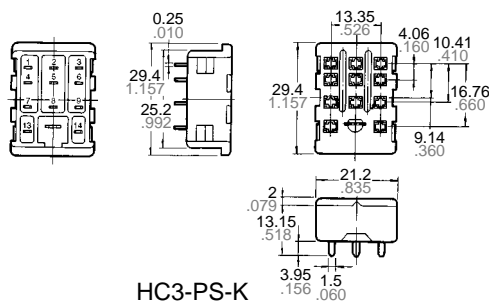

HC3-PS-K

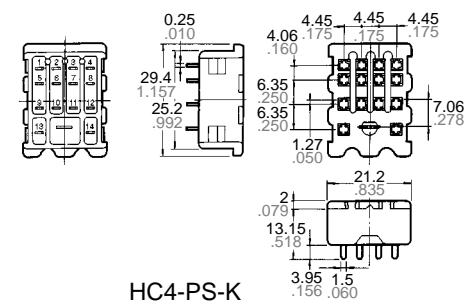

HC4-PS-K

Socket for wrapping (with hold-down clip)

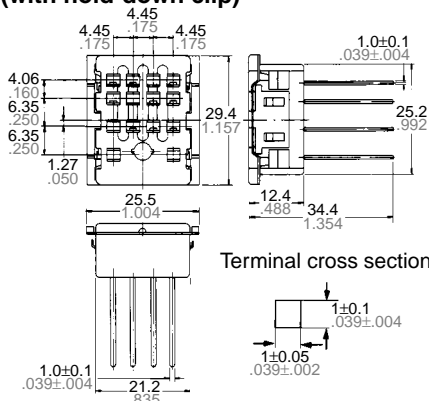

HC4-WS-K

Screw terminal socket for front wiring (with hold-down clip)

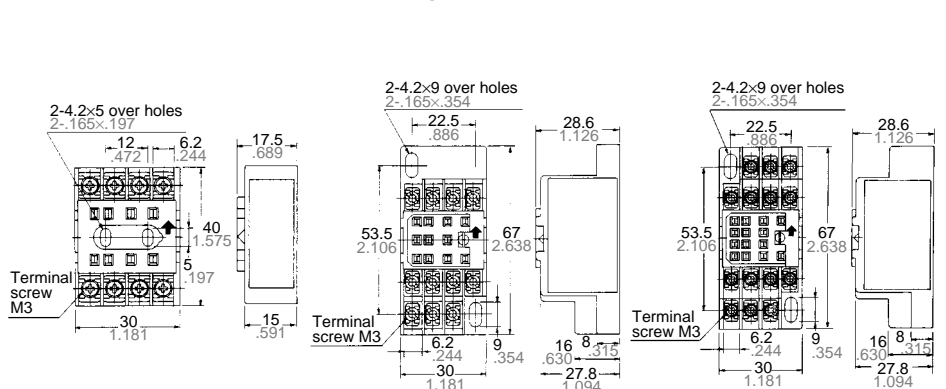

HC2-SF-K

HC3-HSF-K

HC4-HSF-K

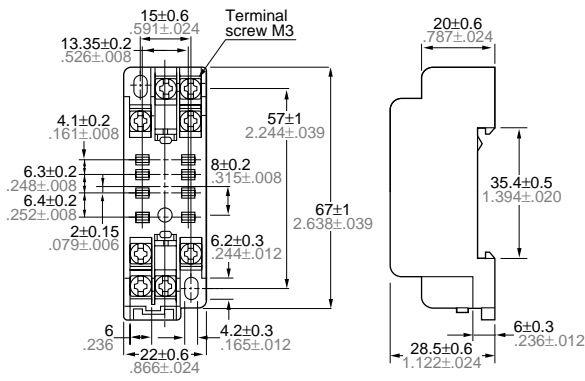

HC2-SFD-S

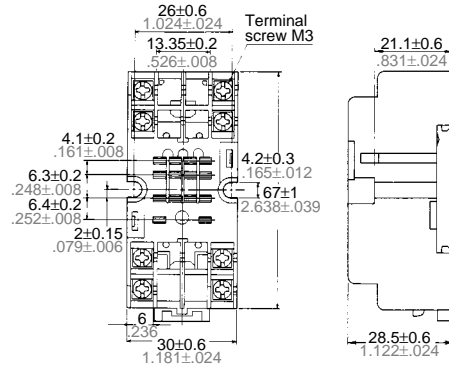

HC2-SFD-K

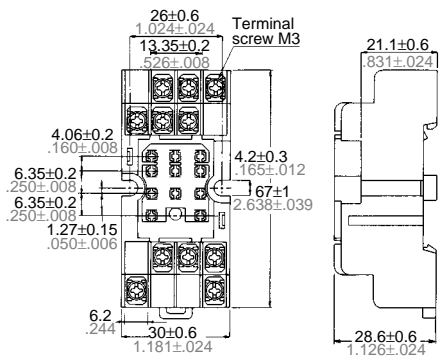

HC3-SFD-K

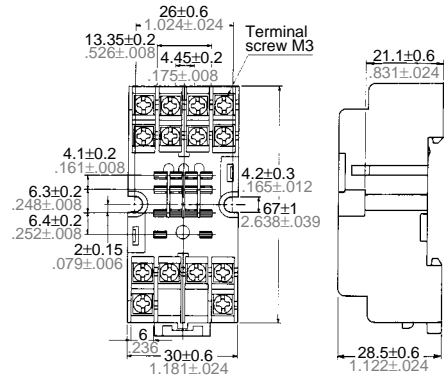

HC4-SFD-K

Hold-down clip

(1) Leaf spring: Applied to HC1-SS-K, HC2-SS-K, HC3-SS-K, HC4-SS-K, HC1-PS-K, HC2-PS-K, HC3-PS-K, HC4-PS-K, HC2-SF-K, HC3-HSF-K, HC4-HSF-K

Part No.: HC/HL-LEAF-SPRING-K

(2) "M shape" leaf spring: Applied to HC1-WS-K, HC2-WS-K, HC3-WS-K, HC4-WS-K

Part No.: HC/HL-LEAF-SPRING-MK

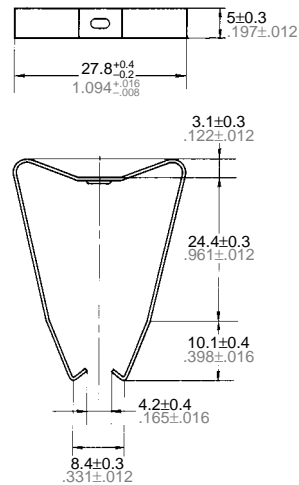
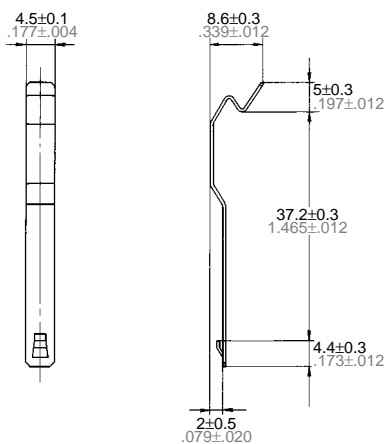

MOUNTING DIMENSIONS AND METHOD

Solder and wrapping socket mount

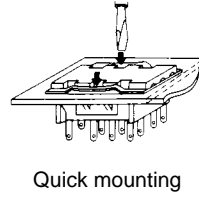
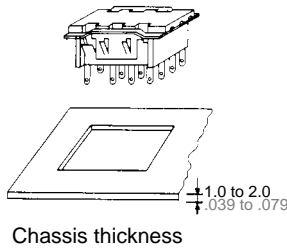

Chassis cutout

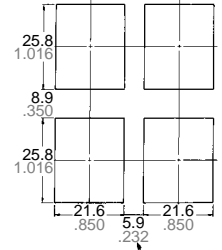

Tolerance: $\pm 0.1 \pm 0.004$

PC board pattern for PC board socket (Copper-side view)

For socket-mount

HC1-PS-K

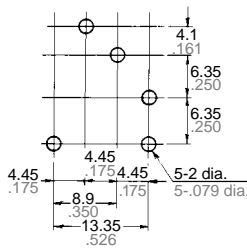

HC2-PS-K

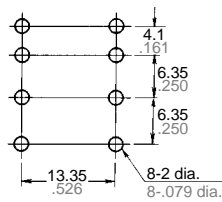

HC3-PS-K

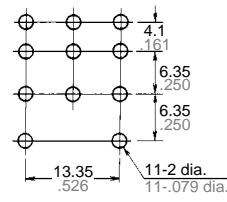

HC4-PS-K

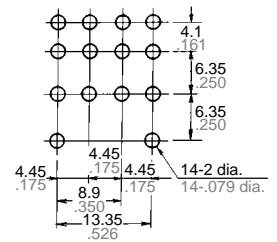

General tolerance: $\pm 0.5 \pm 0.020$

Screw socket mounts (Top view)

HC2-SF-K

Chassis cutout

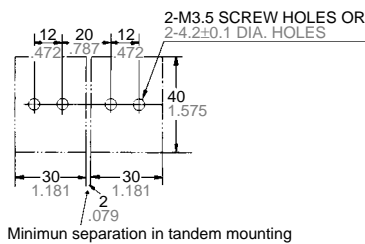

Schematic



HC3-HSF-K

Chassis cutout

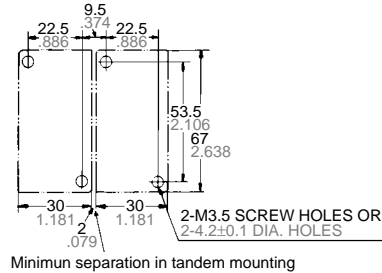

Schematic

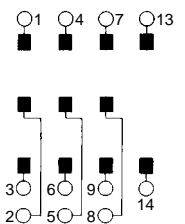

HC4-HSF-K

Chassis cutout

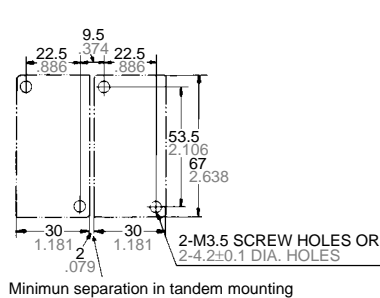

Schematic

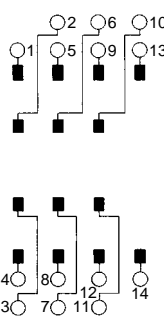

HC2-SFD-K

Chassis cutout

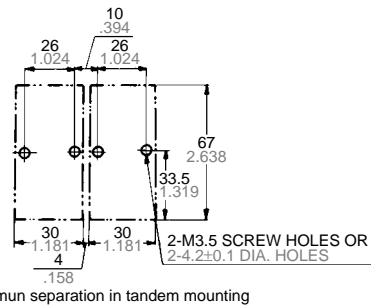

Schematic

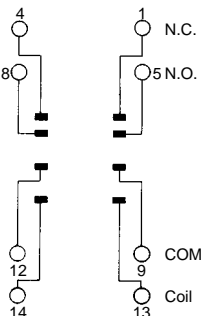

HC3-SFD-K

Chassis cutout

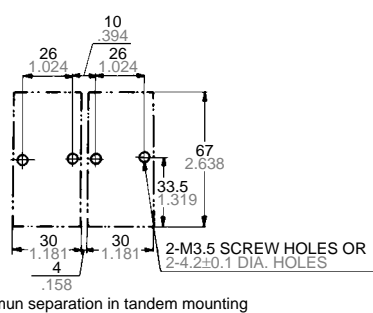

Schematic

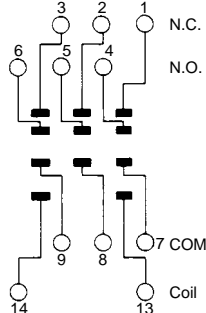

HC4-SFD-K

Chassis cutout

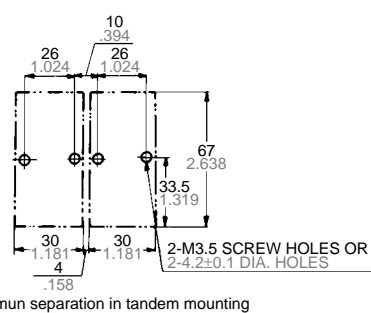

Schematic

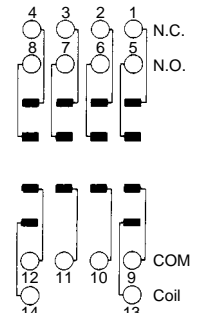

HC

Direct mount for HC-TM relay series

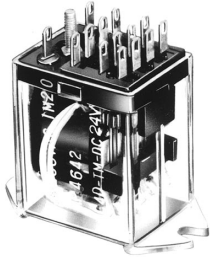

HC-HTM

4 Form C

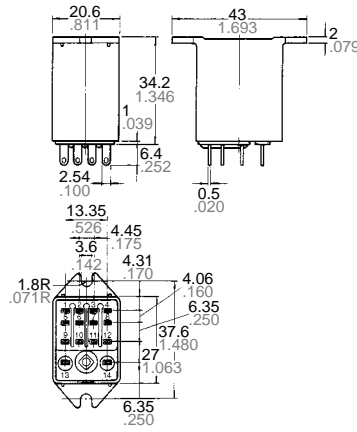

CHASSIS CUTOUT IN TANDEM MOUNTING

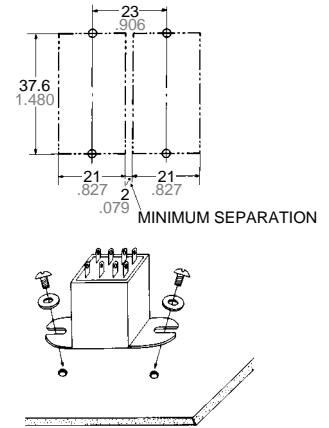

Tolerance: $\pm 0.1 \pm 0.04$

Notes:

1. HC 1-HTM, HC2-HTM, HC3-HTM, HC4-HTM types all have dimensions in common except for the number of terminals.
2. For the specifications, please refer to Page 395.
3. In mounting, use M3 screw and M3 washer.

Mounting track for solder socket

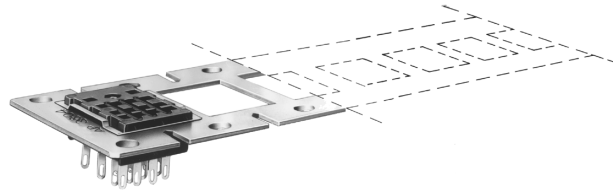

Up to 10 sockets per track.
Cut at notch for desired track length.

Track-mounted solder log sockets HC-MOUNTING TRACK

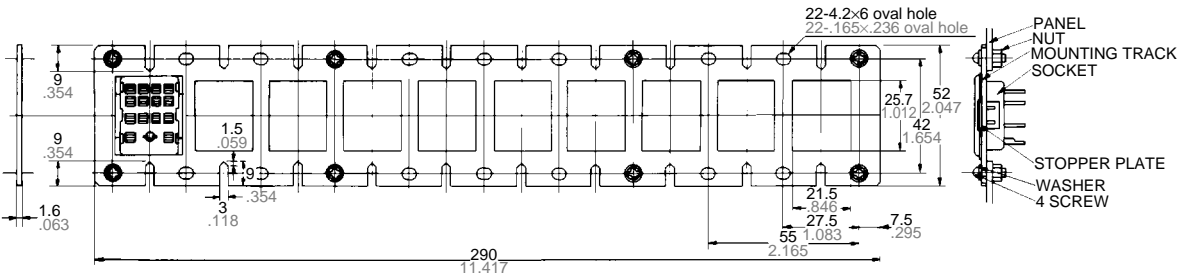

Chassis

For small quantity

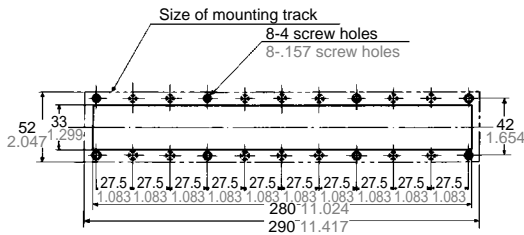

For large quantity

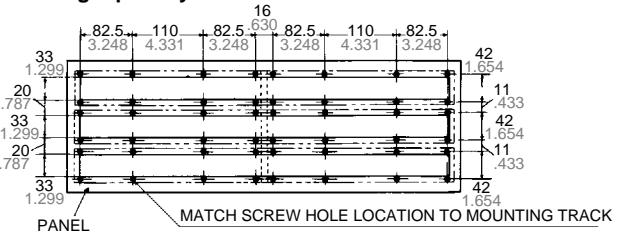

Tolerance: $\pm 0.1 \pm 0.04$

For Cautions for Use, see Relay Technical Information (Page 48 to 76).