

T-Series Relays

T series Cautions for Use

1. Coil operating power

Pure DC current should be applied to the coil. The wave form should be rectangular. If it includes ripple, the ripple factor should be less than 5%.

However, check it with the actual circuit since the characteristics may be slightly different.

The nominal operating voltage should be applied to the coil for more than 10 ms to set/reset the latching type relay.

2. Coil connection

When connecting coils, refer to the wiring diagram to prevent mis-operation or malfunction.

3. External magnetic field

Since T-Series relays are highly sensitive polarized relays, their characteristics will be affected by a strong external magnetic field.

Avoid using the relay under that conditions.

4. Conditions for operation, transport and storage

1) Ambient temperature, humidity, and atmospheric pressure during usage, transport, and storage of the relay:

TX(-SMD)/TX-D(-SMD)/TQ-SMD

(1) Temperature:

-40 to +85°C -40 to +185°F.

The temperature range is -40 to +70°C

-40 to +158°F for the packaged relay.

TX-S(-SMD)

(1) Temperature:

-40 to +70°C -40 to +158°F. for the package/non-package relay.

(2) Humidity: 5 to 85% R.H.

TQ/TF/TN/TK

(1) Temperature: -40 to +70°C -40 to

+158°F

The temperature range is -40 to +60°C

-40 to +140°F for the packaged relay.

(2) Humidity: 5 to 85% R.H.

(Avoid freezing and condensation.)

The humidity range varies with the temperature.

Use within the range indicated in the graph below.

(3) Atmospheric pressure: 86 to 106 kPa

Temperature and humidity range for usage, transport, and storage:

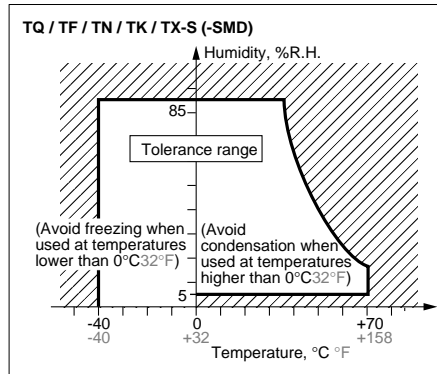

2) Condensation

Condensation forms when there is a sudden change in temperature under high temperature, high humidity conditions. Condensation will cause deterioration of the relay insulation.

3) Freezing

Condensation or other moisture may freeze on the relay when the temperature is lower than 0°C 32°F.

This causes problems such as sticking of movable parts or operational time lags.

4) Low temperature, low humidity environments

The plastic becomes brittle if the relay is exposed to a low temperature, low humidity environment for long periods of time.

5. M.B.B. contact relays

A small OFF time may be generated by the contact bounce during contact switching. Check the actual circuit carefully. If the relay is dropped accidentally, check the appearance and characteristics including M.B.B. time before use.

6. Packing style

1) Tube orientation for both standard through hole terminal type (including self-clinching type) and surface-mount terminal type.

The relay is packed in a tube with the relay orientation mark on the left side, as shown in the figure below.

Take note of the relay orientation when mounting relays on the printed circuit board.

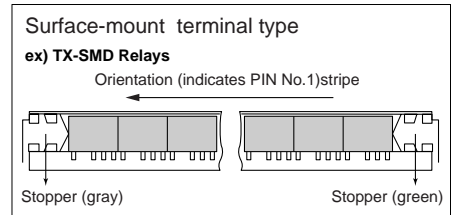
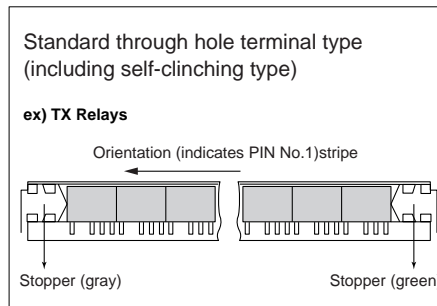

(2) Tape and reel packing (surface-mount terminal type)

(1) Tape dimensions

1. TX/TX-D/TX-S-SMD Relays

(i) SA type

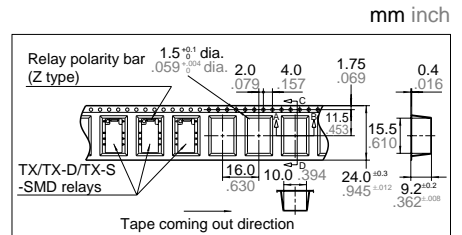

(ii) SL type

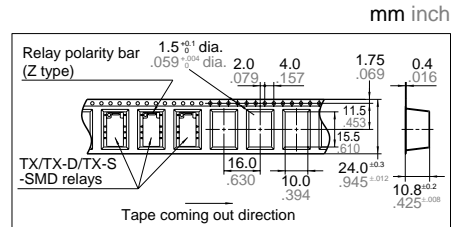

(iii) SS type

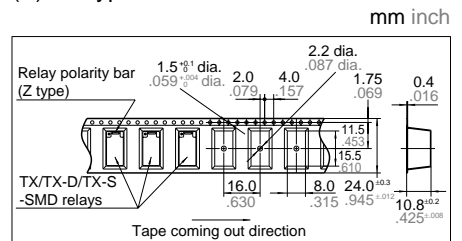

2. TQ-SMD Relays

(i) SA type

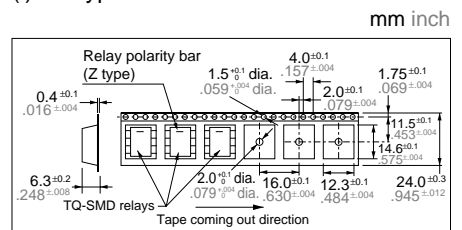

(ii) SL, SS type

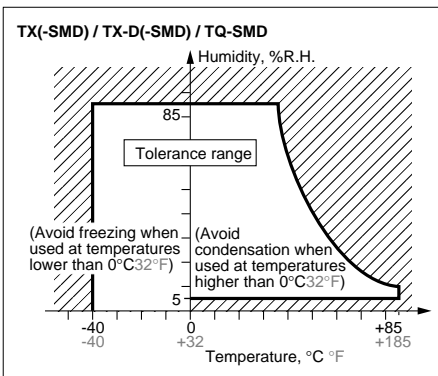
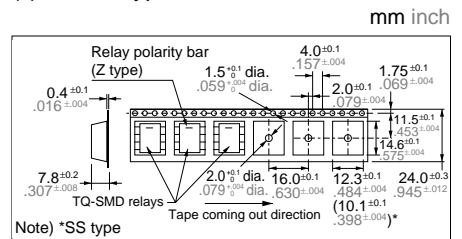

(2) Dimensions of plastic reel

(i) TX/TX-D/TX-S-SMD Relays

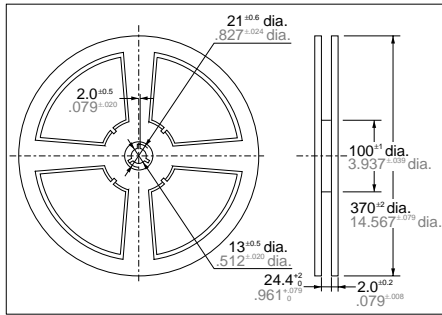

(ii) TQ-SMD Relays

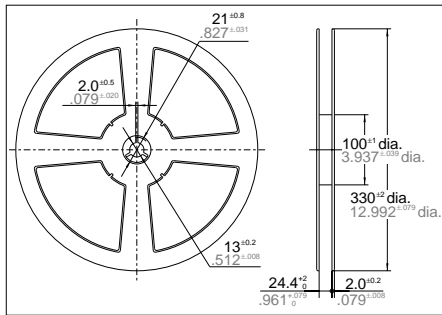

7. Automatic insertion

To maintain the internal function of the relay, the chucking pressure should not exceed the values below.

1) TX(-SMD)/TX-D(-SMD)/TQ/TF

Chucking pressure in the direction A:

4.9 N {500 g} or less

Chucking pressure in the direction B:

9.8 N {1 kg} or less

Chucking pressure in the direction C:

9.8 N {1 kg} or less

TX(-SMD)/TX-D(-SMD)/TX-S(-SMD)

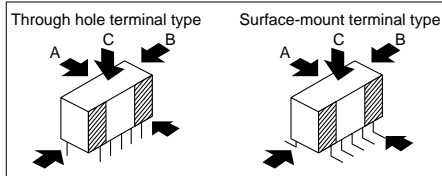

TQ

TF

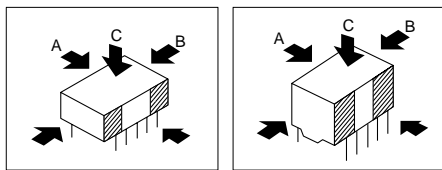

Please chuck the portion.

Avoid chucking the center of the relay.

2) TQ-SMD

Chucking pressure in the direction A:

9.8 N {1 kg} or less

Chucking pressure in the direction B:

9.8 N {1 kg} or less

Mounting pressure in the direction C:

9.8 N {1 kg} or less

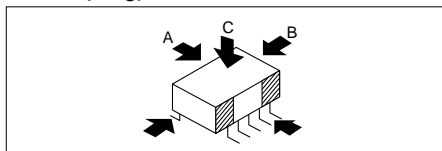

Please chuck the portion.

Avoid chucking the center of the relay.

3) TN

Chucking pressure in the direction A:

9.8 N {1 kg} or less

Chucking pressure in the direction B:

9.8 N {1 kg} or less

Chucking pressure in the direction C:

4.9 N {500 g} or less

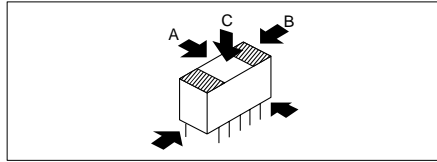

Please chuck the portion.

Avoid chucking the center of the relay.

4) TK

Chucking pressure* in the direction A:

9.8 N {1 kg} or less

Chucking pressure* in the direction B:

29.4 N {3 kg} or less

Chucking pressure* in the direction C:

9.8 N {1 kg} or less

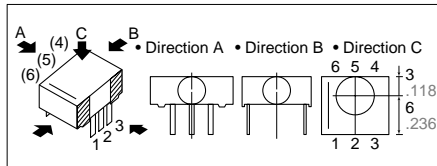

Please chuck the portion.

Avoid chucking the center of the relay.

*Value of chucking pressure is shown by the value of weight pressed on the portion (4 mm dia.)

8. Soldering

1) Preheat according to the following conditions.

Temperature	100°C 212°F or less
Time	Within approx. 1 minute

When soldering standard PC board terminals or self-clinching terminals, soldering should be done at 250°C 482°F within 5 sec.

2) When soldering surface-mount terminals, the following conditions are recommended.

(1) IR (Infrared reflow) soldering method

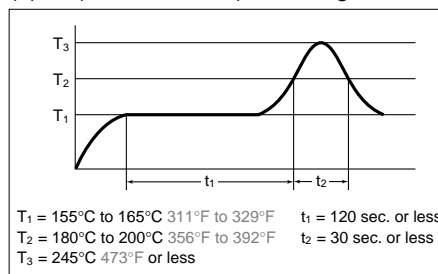

(2) Vapor phase soldering method

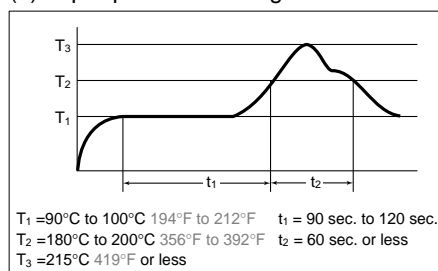

(3) Soldering iron method

Tip temperature: 280°C to 300°C 536°F to 572°C

Wattage: 30 to 60 W

Soldering time: within 5 sec.

(4) Other soldering methods

Check mounting conditions before using other soldering methods (hot-air, hot plate, pulse heater, etc.).

Remarks

The temperature profile indicates the temperature of the soldered terminal on the surface of the PC board.

The ambient temperature may increase excessively.

Check the temperature under mounting conditions.

The conditions for the infrared reflow soldering apply when preheating using the VPS method.

9. Cleaning

In automatic cleaning, cleaning with the boiling method is recommended. Avoid ultrasonic cleaning which subject the relay to high frequency vibrations. It may cause the contacts to stick.

It is recommended that a fluorinated hydrocarbon or other alcoholic solvents be used.

10. Others

1) If in error the relay has been dropped, the appearance and characteristics should be checked before use without fail.

2) The cycle lifetime is defined under the standard test condition specified in the JIS* C 5442-1986 standard (temperature 15 to 35°C 59 to 95°F, humidity 25 to 85%). Check this with the real device as it is affected by coil driving circuit, load type, activation frequency, activation phase, ambient conditions and other factors.

3) For secure operations, the voltage applied to the coil should be nominal voltage. In addition, please note that pick-up and drop-out voltage will vary according to the ambient temperature and operation conditions.

4) Latching relays are shipped from the factory in the reset state. A shock to the relay during shipping or installation may cause it to change to the set state.

Therefore, it is recommended that the relay be used in a circuit which initializes the relay to the required state (set or reset) whenever the power is turned on.

5) Check the ambient conditions when storing or transporting the relays and devices containing the relays. Freezing or condensation may occur in the relay, causing functional damage. Avoid subjecting the relays to heavy loads, or strong vibration and shocks.

*Japanese Industrial Standards