

NiS

SMALL POLARIZED RELAY WITH HIGH SENSITIVITY 50mW

TX-S RELAYS

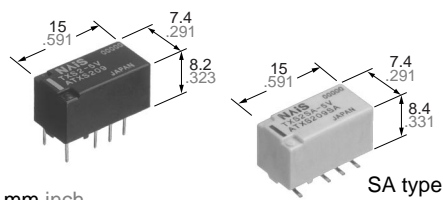

FEATURES

- High sensitivity**
 - 50mW nominal operating power (single side stable 1.5-12V)
 - Useful for electric-power-saving
- Approx. 0.3μV low thermal electromotive force**

- Outstanding surge resistance**
 - Surge withstand between open contacts: 1,500V 10×160μs (FCC part 68)
 - Surge withstand between contacts and coil: 2,500V 2×10μs (Bellcore)

SPECIFICATIONS

Contact

Arrangement	2 Form C	
Initial contact resistance, max. (By voltage drop 6 V DC 1 A)	100 mΩ	
Contact material	Gold-clad silver alloy	
Rating	Nominal switching capacity (resistive load)	1 A 30 V DC
	Max. switching power (resistive load)	30 W (DC)
	Max. switching voltage	110 V DC
	Max. switching current	1 A
	Min. switching capacity *1	10 μA 10 mV DC
Nominal operating power	Single side stable	50 mW (1.5 to 12 V DC) 70 mW (24 V DC)
	1 coil latching	35 mW (1.5 to 12 V DC) 50 mW (24 V DC)
	2 coil latching	70 mW (1.5 to 12 V DC) 150 mW (24 V DC)
Expected life (min. operations)	Mechanical (at 180 cpm)	5×10 ⁷
	Electrical (at 20 cpm) 1 A 30 V DC resistive	2×10 ⁶

Note:

*1 This value can change due to the switching frequency, environmental conditions, and desired reliability level, therefore it is recommended to check this with the actual load.

Remarks

- * Specifications will vary with foreign standards certification ratings.
- *1 Measurement at same location as "Initial breakdown voltage" section.
- *2 Detection current: 10mA
- *3 Excluding contact bounce time.
- *4 By resistive method; nominal voltage applied to the coil; contact carrying current: 1 A.
- *5 Half-wave pulse of sine wave: 6 ms; detection time: 10 μs

Characteristics

Initial insulation resistance*1	Min. 1,000 MW (at 500 V DC)	
Initial breakdown voltage*2	Between open contacts	750 Vrms for 1min.
	Between contact sets	1,000 Vrms for 1min.
Initial surge voltage	Between contacts and coil	1,800 Vrms for 1min.
	Between open contacts (10 × 160μs)	1,500V (FCC Part 68)
Operate time [Set time]*3 (at 20°C)(at nominal voltage)	Between contacts and coil (2 × 10 μs)	2,500V (Bellcore)
	Release time (without diode) [Reset time]*3 (at 20°C)(at nominal voltage)	Max. 5 ms (Approx. 3 ms) [Max. 5 ms (Approx. 3 ms)]
Temperature rise*4 (at 20°C)	Max. 50°C	
Shock resistance	Functional*5	Min. 750 m/s ² {75 G}
	Destructive*6	Min. 1,000 m/s ² {100 G}
Vibration resistance	Functional*7	10 to 55 Hz at double amplitude of 3.3 mm
	Destructive	10 to 55 Hz at double amplitude of 5 mm
Conditions for operation, transport and storage*8 (Not freezing and condensing at low temperature)	Ambient temperature	-40°C to +70°C -40°F to +158°F
	Humidity	5 to 85% R.H.
Unit weight	Approx. 2 g .071 oz	

- *6 Half-wave pulse of sine wave: 6 ms
- *7 Detection time: 10 μs
- *8 Refer to 4. Conditions for operation, transport and storage mentioned in Cautions for use (Page 178).

TYPICAL APPLICATIONS

- Telephone equipment
- Measuring equipment
- Communications equipment
- Office Automation equipment

ORDERING INFORMATION

Ex. TXS [2] [SA] - [L] - [H] - [3V] - [Z]

Contact arrangement	Surface-mount availability	Operating function	Terminal shape	Coil voltage (DC)	Packing style
2: 2 Form C	Nil: Standard PC board terminal type or self-clinching terminal type SA: Standard surface-mount terminal type SL: High connection reliability surface-mount terminal type SS: Space saving surface-mount terminal type	Nil: Single side stable L: 1 coil latching L2: 2 coil latching	Nil: Standard PC board terminal or surface-mount terminal H: Self-clinching terminal	1.5, 3, 4.5, 6, 9, 12, 24 V	Nil: Tube packing Z: Tape and reel packing/picked from the 8/9/10/12 -pin side

Notes: 1. Tape and reel (picked from 1/3/4/5-pin side) is also available by request. Part number suffix "-X" is needed when ordering. (ex.) TXS2SA-3 V-X
2. Tape and reel packing symbol "-Z" or "-X" are not marked on the relay.

TX-S

TYPES AND COIL DATA (at 20°C 68°F)

1) Standard PC board terminal type and self-clinching terminal type

Single side stable

Part No.		Nominal voltage, V DC	Pick-up voltage, V DC (max.)	Drop-out voltage, V DC (min.)	Nominal operating current, mA (±10%)	Coil resistance, Ω (±10%)	Nominal operating power, mW	Max. Allowable voltage, V DC
Standard PC board terminal	Self-clinching terminal							
TXS2-1.5V	TXS2-H-1.5V	1.5	1.2	0.15	33.3	45	50	2.2
TXS2-3V	TXS2-H-3V	3	2.4	0.3	16.7	180	50	4.5
TXS2-4.5V	TXS2-H-4.5V	4.5	3.6	0.45	11.1	405	50	6.7
TXS2-6V	TXS2-H-6V	6	4.8	0.6	8.3	720	50	9
TXS2-9V	TXS2-H-9V	9	7.2	0.9	5.6	1,620	50	13.5
TXS2-12V	TXS2-H-12V	12	9.6	1.2	4.2	2,880	50	18
TXS2-24V	TXS2-H-24V	24	19.2	2.4	2.9	8,229	70	36

1 coil latching

Part No.		Nominal voltage, V DC	Set voltage, V DC (max.)	Reset voltage, V DC (Max.)	Nominal operating current, mA (±10%)	Coil resistance, Ω (±10%)	Nominal operating power, mW	Max. Allowable voltage, V DC
Standard PC board terminal	Self-clinching terminal							
TXS2-L-1.5V	TXS2-L-H-1.5V	1.5	1.2	1.2	23.3	64.3	35	2.2
TXS2-L-3V	TXS2-L-H-3V	3	2.4	2.4	11.7	257	35	4.5
TXS2-L-4.5V	TXS2-L-H-4.5V	4.5	3.6	3.6	7.8	579	35	6.7
TXS2-L-6V	TXS2-L-H-6V	6	4.8	4.8	5.8	1,029	35	9
TXS2-L-9V	TXS2-L-H-9V	9	7.2	7.2	3.9	2,314	35	13.5
TXS2-L-12V	TXS2-L-H-12V	12	9.6	9.6	2.9	4,114	35	18
TXS2-L-24V	TXS2-L-H-24V	24	19.2	19.2	2.1	11,520	50	36

2 coil latching

Part No.		Nominal voltage, V DC	Set voltage, V DC (max.)	Reset voltage, V DC (Max.)	Nominal operating current, mA (±10%)	Coil resistance, Ω (±10%)	Nominal operating power, mW	Max. Allowable voltage, V DC
Standard PC board terminal	Self-clinching terminal							
TXS2-L2-1.5V	TXS2-L2-H-1.5V	1.5	1.2	1.2	46.7	32.1	70	2.2
TXS2-L2-3V	TXS2-L2-H-3V	3	2.4	2.4	23.3	129	70	4.5
TXS2-L2-4.5V	TXS2-L2-H-4.5V	4.5	3.6	3.6	15.6	289	70	6.7
TXS2-L2-6V	TXS2-L2-H-6V	6	4.8	4.8	11.7	514	70	9
TXS2-L2-9V	TXS2-L2-H-9V	9	7.2	7.2	7.8	1,157	70	13.5
TXS2-L2-12V	TXS2-L2-H-12V	12	9.6	9.6	5.8	2,057	70	18
TXS2-L2-24V	TXS2-L2-H-24V	24	19.2	19.2	6.3	3,840	150	36

Notes:

1. Specified value of pick-up, drop-out, set and reset voltage is with the condition of square wave coil pulse.
2. Standard packing: Tube: 40 pcs.; Case: 1,000 pcs.

2) Surface-mount terminal type

Single side stable

Part No.	Nominal voltage, V DC	Pick-up voltage, V DC (max.)	Drop-out voltage, V DC (min.)	Nominal operating current, mA (±10%)	Coil resistance, Ω (±10%)	Nominal operating power, mW	Max. Allowable voltage, V DC
TXS2S○-1.5 V	1.5	1.2	0.15	33.3	45	50	2.2
TXS2S○-3 V	3	2.4	0.3	16.7	180	50	4.5
TXS2S○-4.5 V	4.5	3.6	0.45	11.1	405	50	6.7
TXS2S○-6 V	6	4.8	0.6	8.3	720	50	9
TXS2S○-9 V	9	7.2	0.9	5.6	1,620	50	13.5
TXS2S○-12 V	12	9.6	1.2	4.2	2,880	50	18
TXS2S○-24 V	24	19.2	2.4	2.9	8,229	70	36

1 coil latching

Part No.	Nominal voltage, V DC	Set voltage, V DC (max.)	Reset voltage, V DC (max.)	Nominal operating current, mA ($\pm 10\%$)	Coil resistance, Ω ($\pm 10\%$)	Nominal operating power, mW	Max. Allowable voltage, V DC
TXS2SO-L-1.5 V	1.5	1.2	1.2	23.3	64.3	35	2.2
TXS2SO-L-3 V	3	2.4	2.4	11.7	257	35	4.5
TXS2SO-L-4.5 V	4.5	3.6	3.6	7.8	579	35	6.7
TXS2SO-L-6 V	6	4.8	4.8	5.8	1,029	35	9
TXS2SO-L-9 V	9	7.2	7.2	3.9	2,314	35	13.5
TXS2SO-L-12 V	12	9.6	9.6	2.9	4,114	35	18
TXS2SO-L-24 V	24	19.2	19.2	2.1	11,520	50	36

2 coil latching

Part No.	Nominal voltage, V DC	Set voltage, V DC (max.)	Reset voltage, V DC (max.)	Nominal operating current, mA ($\pm 10\%$)	Coil resistance, Ω ($\pm 10\%$)	Nominal operating power, mW	Max. Allowable voltage, V DC
TXS2SO-L2-1.5 V	1.5	1.2	1.2	46.7	32.1	70	2.2
TXS2SO-L2-3 V	3	2.4	2.4	23.3	129	70	4.5
TXS2SO-L2-4.5 V	4.5	3.6	3.6	15.6	289	70	6.7
TXS2SO-L2-6 V	6	4.8	4.8	11.7	514	70	9
TXS2SO-L2-9 V	9	7.2	7.2	7.8	1,157	70	13.5
TXS2SO-L2-12 V	12	9.6	9.6	5.8	2,057	70	18
TXS2SO-L2-24 V	24	19.2	19.2	6.3	3,840	150	36

○: For each surface-mounted terminal variation, input the following letter.
SA type: A, SL type: L, SS type: S

Notes:

- Specified value of pick-up, drop-out, set and reset voltage is with the condition of square wave coil pulse.
- Standard packing: Tube: 40 pcs. ; Case: 1,000 pcs.
- Tape and reel packing is also available for surface-mount type by request. Part number suffix "-X" or "-Z" is needed when ordering. In this case, "X" or "Z" are not marked on the relay.
Quantity in tape and reel: 500 pcs.
(ex.) • TXS2SA-3V-X • TXS2SA-L-3V-Z
└ Picked from the 1/3/4/5-pin side └ Picked from the 8/9/10/12-pin side

DIMENSIONS

mm inch

1. Single side stable and 1 coil latching type
Standard PC board terminal

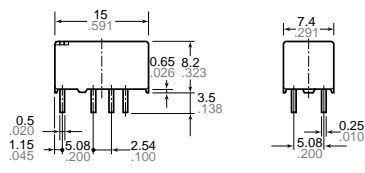
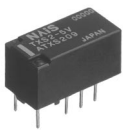

PC board pattern
(Copper-side view)

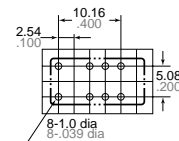

Tolerance: $\pm 0.1 \pm .004$

Schematic (Bottom view)
Single side stable (Deenergized condition) 1 coil latching (Reset condition)

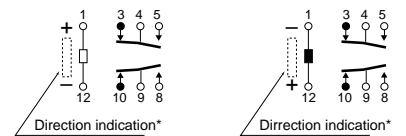

Self clinching terminal

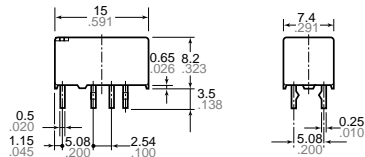

General tolerance: $\pm 0.3 \pm .012$

TX-S

Surface-mount terminal
SA type

mm inch

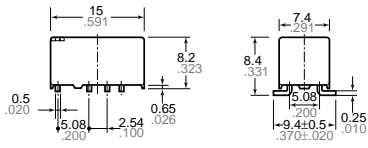

Suggested mounting pad
(Top view)

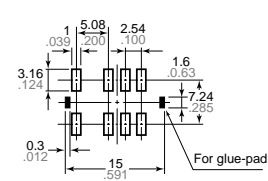

Schematic (Top view)
Single side stable
(Deenergized condition) 1 coil latching
(Reset condition)

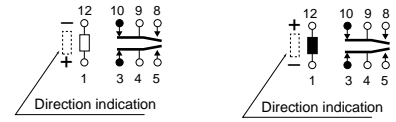

SL type

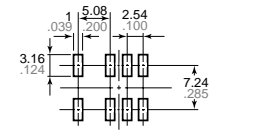
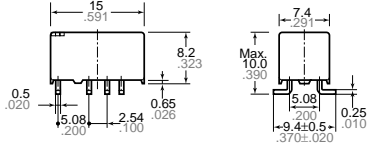

SS type

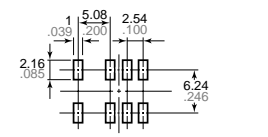
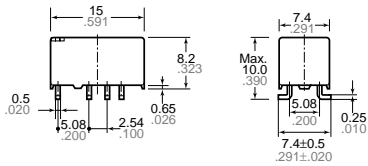

General tolerance: $\pm 0.3 \pm 0.12$

Tolerance: $\pm 0.1 \pm 0.004$

2. Coil latching type

Standard PC board terminal

PC board pattern
(Copper side view)

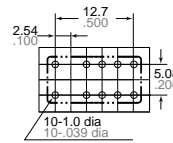

Schematic (Bottom view)
2 coil latching
(Reset condition)

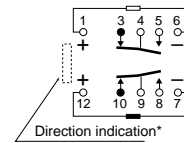

Tolerance: $\pm 0.1 \pm 0.004$

Self clinching terminal

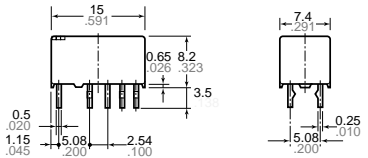

General tolerance: $\pm 0.3 \pm 0.12$

Surface-mount terminal
SA type

Suggested mounting pad
(Top view)

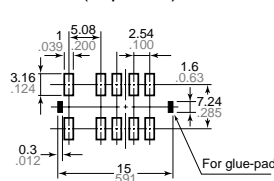

Schematic (Top view)
1 coil latching
(Reset condition)

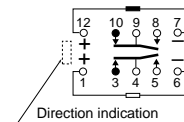

SL type

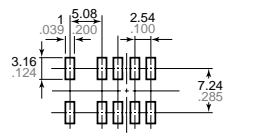
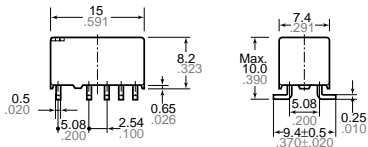

SS type

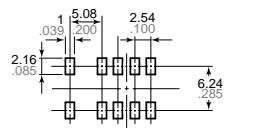
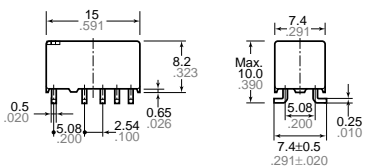

General tolerance: $\pm 0.3 \pm 0.12$

Tolerance: $\pm 0.1 \pm 0.004$

REFERENCE DATA

1. Maximum switching capacity

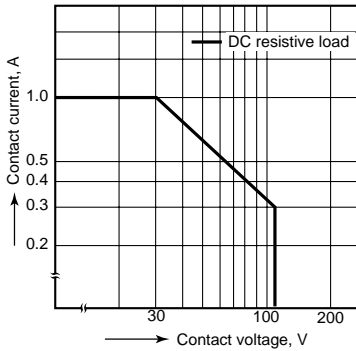

2. Life curve

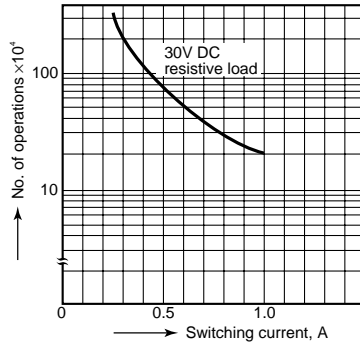

3. Mechanical life

Tested sample: TXS2-4.5V, 10 pcs.
Operating frequency: 180 cpm

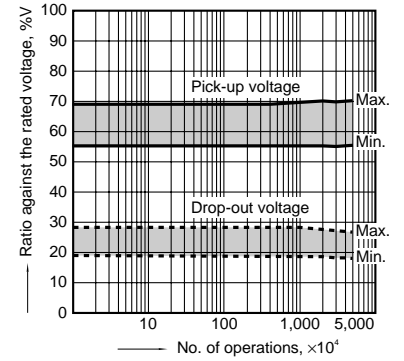

4. Electrical life (1 A 30 V DC resistive load)

Tested sample: TXS2-4.5V, 6 pcs.

Operating frequency: 20 cpm

Change of pick-up and drop-out voltage

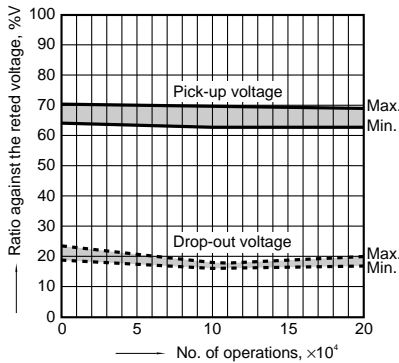

Change of contact resistance

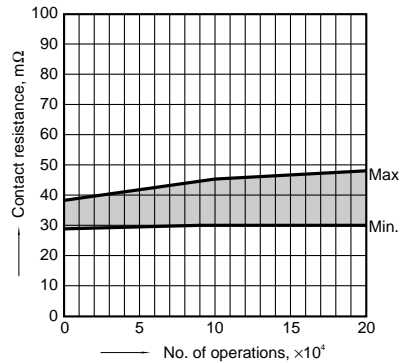

5-(1). Coil temperature rise

Tested sample: TXS2-4.5V, 6 pcs.

Point measured: Inside the coil

Ambient temperature: 25°C 77°F, 70°C 158°F

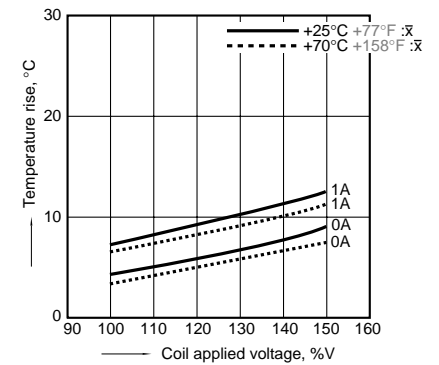

5-(2). Coil temperature rise

Tested sample: TXS2-24V, 6 pcs.

Point measured: Inside the coil

Ambient temperature: 25°C 77°F, 70°C 158°F

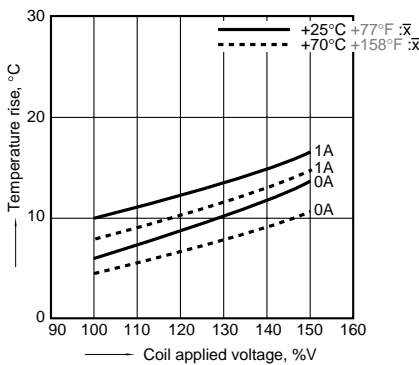

6-(1). Operate and release time (with diode)

Tested sample: TXS2-4.5V, 10 pcs.

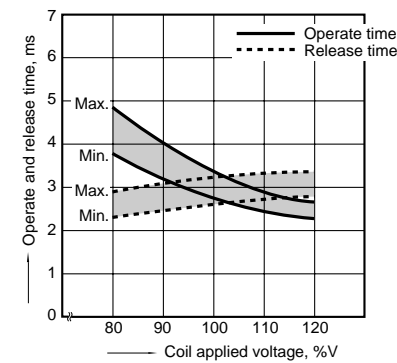

6-(2). Operate and release time (without diode)

Tested sample: TXS2-4.5V, 10 pcs.

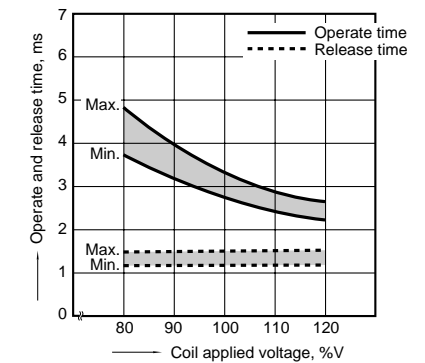

7. Distribution of pick-up and drop-out voltage

Tested sample: TXS2-4.5V, 50 pcs.

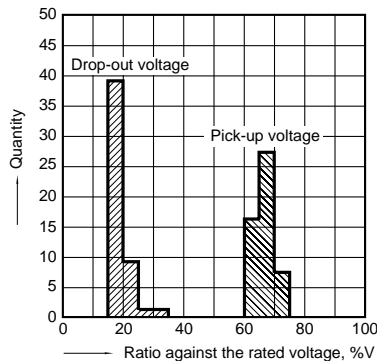

8. Distribution of set and reset voltage

Tested sample: TXS2-4.5V 30 pcs.

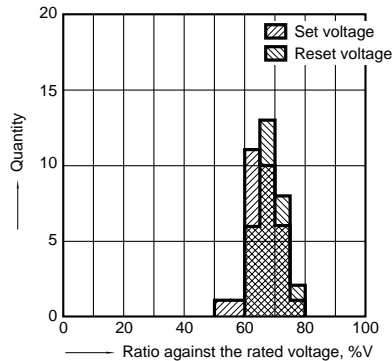

9. Ambient temperature characteristics

Tested sample: TXS2-4.5V 5 pcs.

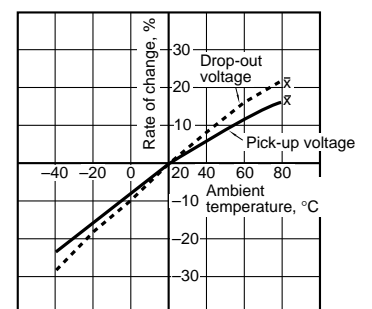

TX-S

10. Distribution of contact resistance

Tested sample: TXS2-4.5V, 50 pcs. (50x4 contacts)

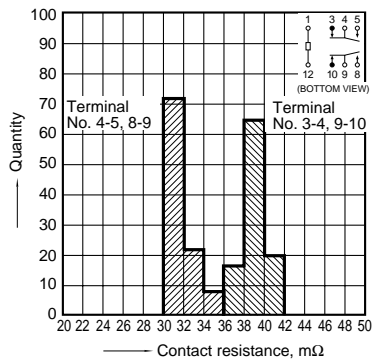

11-(1). High frequency characteristics

Tested sample: TXS2-4.5V, 2 pcs.

Isolation characteristics

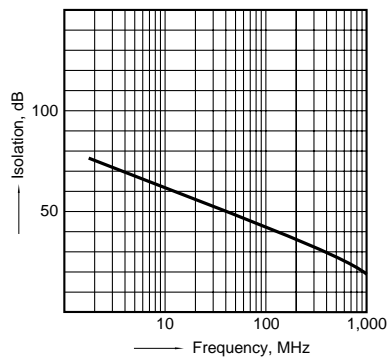

11-(2). High frequency characteristics

Tested sample: TXS2-4.5V, 2 pcs.

Insertion loss characteristics

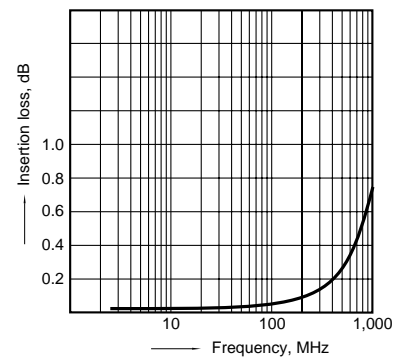

12-(1). Malfunctional shock (single side stable)

Tested sample: TXS2-4.5V, 6 pcs.

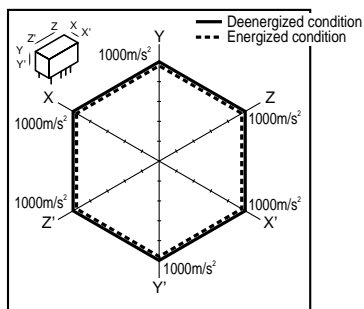

12-(2). Malfunctional shock (latching)

Tested sample: TXS2-L2-4.5V, 6 pcs.

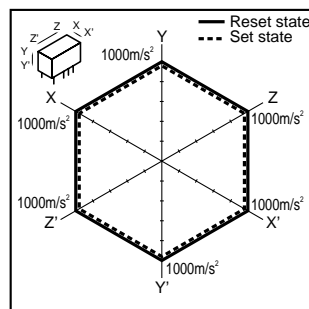

13. Thermal electromotive force

Tested sample: TXS2-4.5V, 10 pcs.

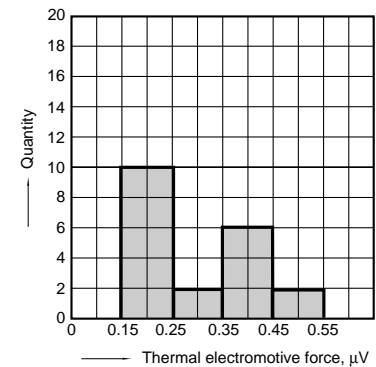

14-(1). Influence of adjacent mounting

Tested sample: TXS2-4.5V, 6 pcs.

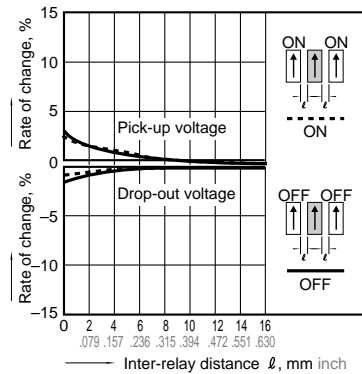

14-(2). Influence of adjacent mounting

Tested sample: TXS2-4.5V, 6 pcs.

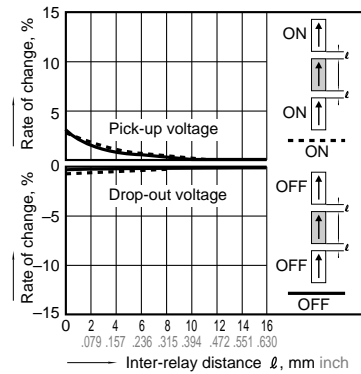

14-(3). Influence of adjacent mounting

Tested sample: TXS2-4.5V, 6 pcs.

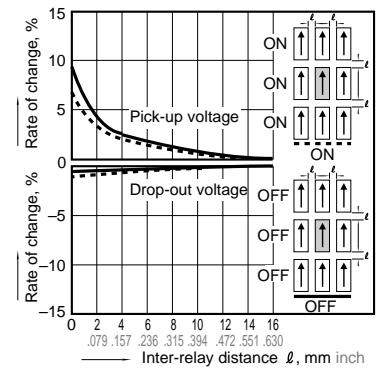

15. Pulse dialing test

Tested sample: TXS2-4.5V, 6 pcs.

(35 mA 48V DC wire spring relay load)

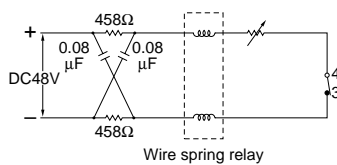

Change of pick-up and drop-out voltage

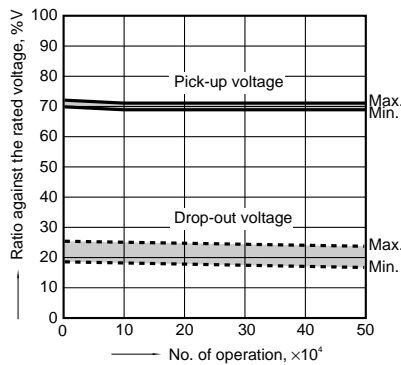

Change of contact resistance

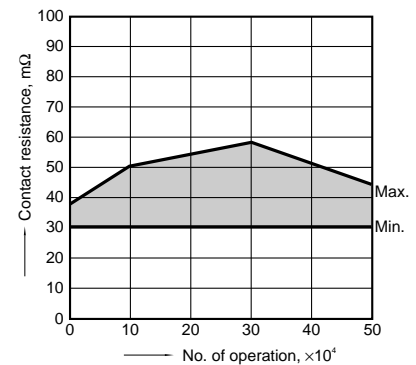

Note: Data of surface-mount type are the same as those of PC board terminal type.

For Cautions for Use, see Page 178 and 179.